

SENGBUSCH

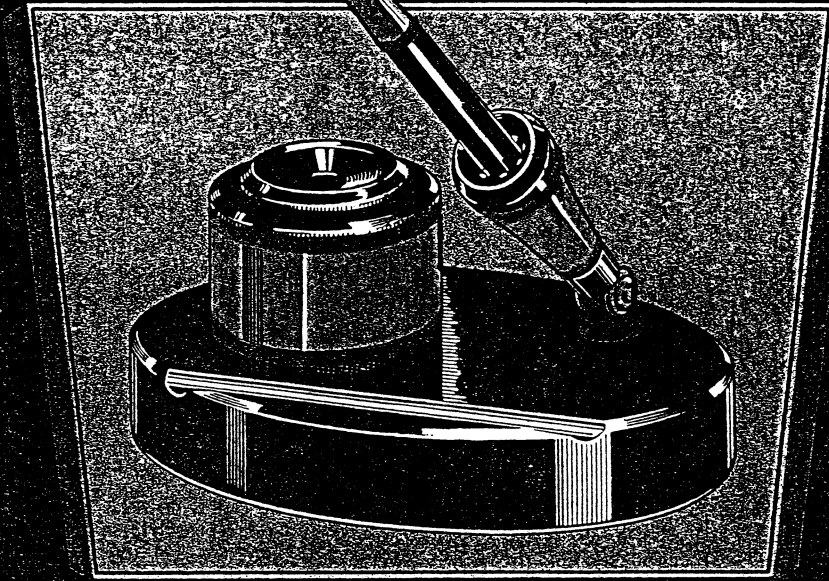

SELF-CLOSING INKSTANDS
INKSTAND SETS AND BASES
DIPADAY DESK SETS
IDEAL SANITARY MOISTENERS
NO-OVER-FLO SPONGE CUPS
KLERADESK

SENGBUSCH

CATALOG NUMBER 22

EFFECTIVE SEPTEMBER 1ST 1929

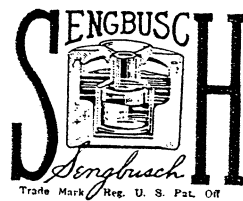

SENGBUSCH SELF-CLOSING INKSTAND Co.
MILWAUKEE, WIS., U.S.A.

Dipaday Pens in Colors

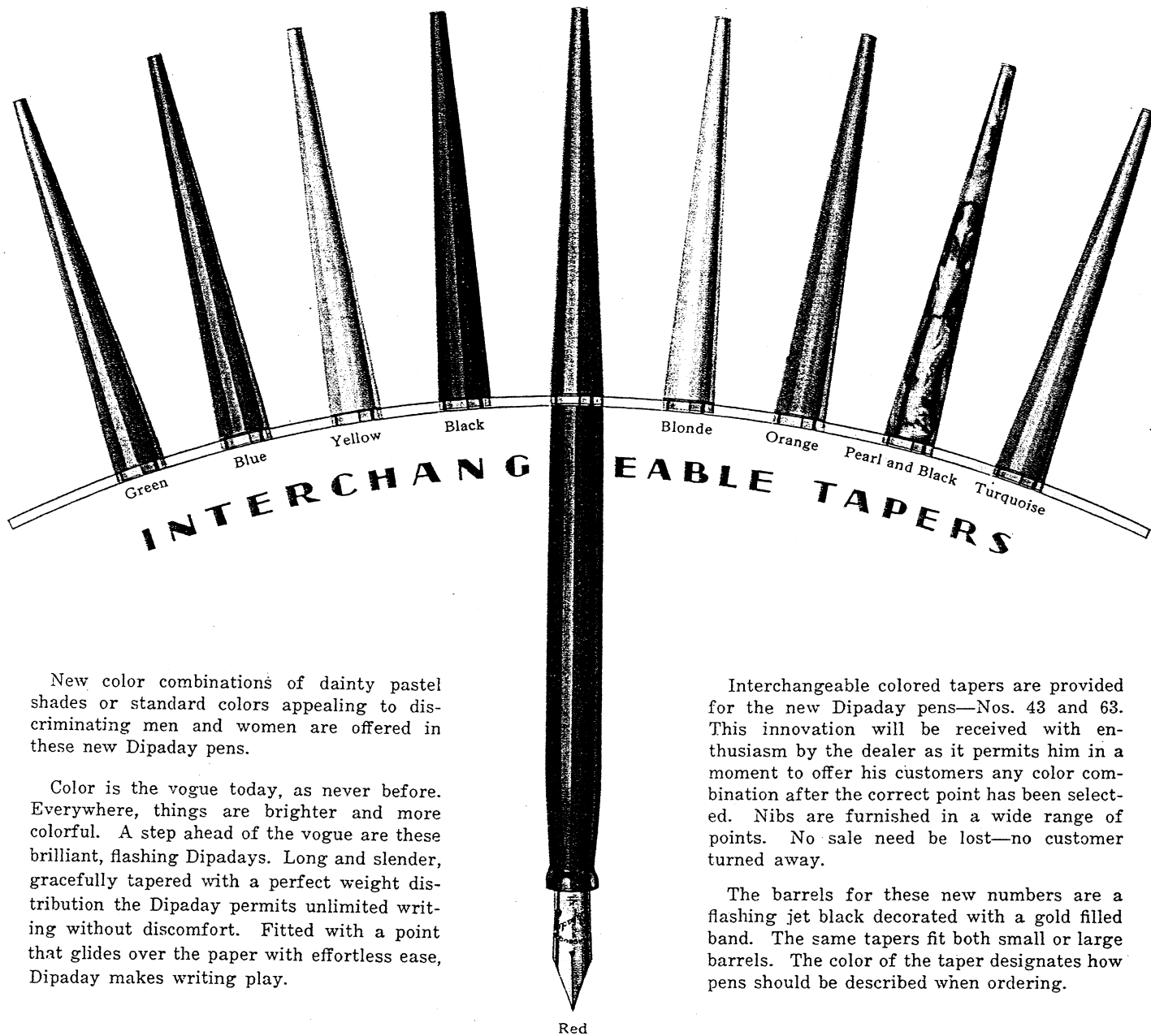

New color combinations of dainty pastel shades or standard colors appealing to discriminating men and women are offered in these new Dipaday pens.

Color is the vogue today, as never before. Everywhere, things are brighter and more colorful. A step ahead of the vogue are these brilliant, flashing Dipadays. Long and slender, gracefully tapered with a perfect weight distribution the Dipaday permits unlimited writing without discomfort. Fitted with a point that glides over the paper with effortless ease, Dipaday makes writing play.

Interchangeable colored tapers are provided for the new Dipaday pens—Nos. 43 and 63. This innovation will be received with enthusiasm by the dealer as it permits him in a moment to offer his customers any color combination after the correct point has been selected. Nibs are furnished in a wide range of points. No sale need be lost—no customer turned away.

The barrels for these new numbers are a flashing jet black decorated with a gold filled band. The same tapers fit both small or large barrels. The color of the taper designates how pens should be described when ordering.

Order Pens by Number, Point and Color

No. 43—Flexible, Extra Fine, Fine, Medium or Stub Point (Set with No. 4 Nib).....	\$3.50
No. 43—Manifold, Extra Fine, Fine or Medium Point (Set with No. 4 Nib).....	4.00
No. 63—Flexible, Extra Fine, Fine, Medium or Stub Point (Set with No. 6 Nib).....	5.50
No. 63—Manifold, Extra Fine, Fine or Medium Point (Set with No. 6 Nib).....	6.00

Choice of Nine Colors for Nos. 43 and 63 Pens

Green, Blue, Yellow, Black, Red, Blonde, Orange, Black and Pearl and Turquoise.
The color of the taper designates how pens should be described when ordering.

Dipaday Effectually Eliminates all Writing Troubles

Dipaday is a mechanical marvel—simple, practical. This marvelous writing tool, radically different, is daily satisfying thousands of users the country over, and is the culmination of long experiment and tests to produce the finest desk pen ever made.

When Dipaday is used in combination with the Sengbusch Self-Closing Inkstand and Adjustable Socket, 100% Writing Efficiency is assured. The name Sengbusch too, gives Dipaday sales an added impetus—a name famous and popular for more than twenty years, known to stand for quality and long service. These three features represent a trio of outstanding accomplishments in the field of writing equipment. No other set can offer the wonderful efficiency of this irresistible combination.

The Dipaday pen is strictly a desk dip pen for desk work, not a fountain pen. Its construction, however, effectually eliminates all the handicaps of old-fashioned writing methods and definitely ends all writing troubles. No manipulation to fill it. A dip and it's ready to write. By simply dipping the pen deep enough into the ink to submerge all the slots in the hard rubber feed, sufficient ink will be retained to permit several pages to be written, business letter size, depending on the size of the nib, and manner of writing. If used at intervals, one dip will last a whole day.

Fitted with the highest quality 14-K gold, iridium point pen, ground to produce smoothness and easy writing qualities. Constructed to permit the use of any standard brand ink, containing ingredients suited for permanent records. No special free-flowing or so-called fountain pen inks necessary. A writing instrument for ever-ready service.

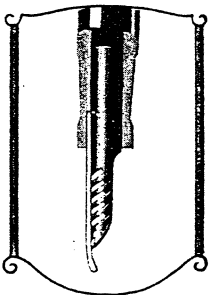

Sectional view of the Dipaday Pen showing simple construction. Barrel, feed with slots and gold nib.

Pen Repair Parts

No.	Nib	Barrel	Feed	Taper	Allowance on old Gold Nib
40	\$2.00	\$.75	\$.25	...	\$.40
60	3.75	1.00	.2560
43	2.00	.75	.25	\$.50	.40
63	3.75	1.00	.25	.50	.60

Manifold Nibs 50 cents extra.

When a new gold pen or any repairs are needed, send the complete pen so the new parts can be properly fitted together.

Mark your name and address plainly on the package so that we can identify it with your letter of instructions. If you desire the package returned by REGISTERED MAIL, enclose additional stamps.

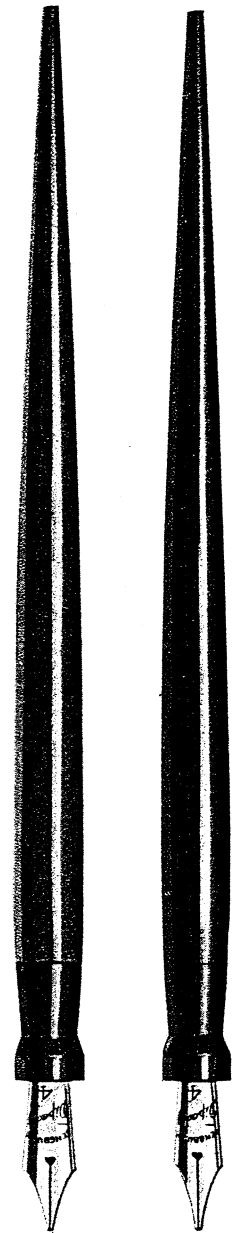

Red Black
No. 40—With No. 4 Nib..\$3.00
No. 60—With No. 6 Nib.. 5.00
With Manifold points, 50 cents extra for each pen.

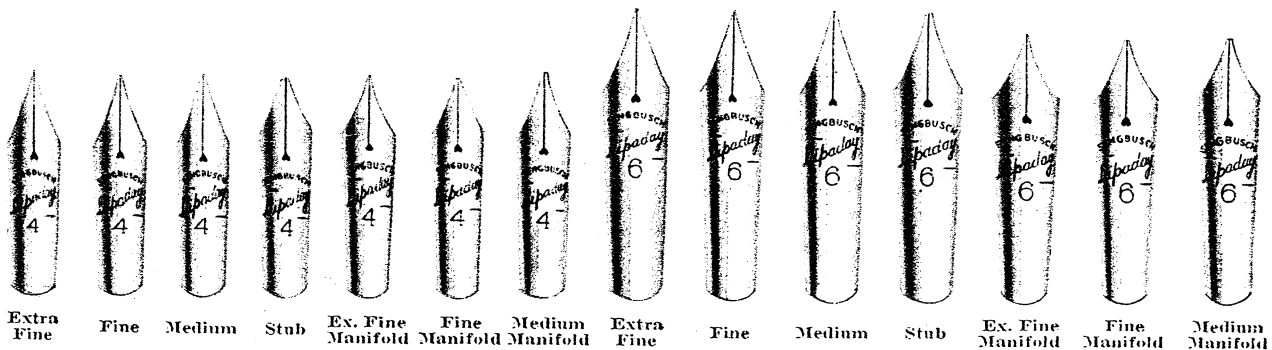

Assorted Nibs in Two Sizes, viz.: No. 4 or No. 6 as illustrated above.

Seymour

Dipaday Desk Sets



The Most Beautiful and Practical Desk Sets Ever Created

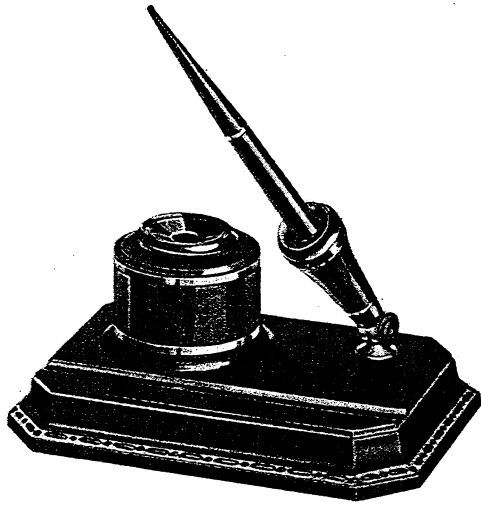

Above Illustrates No. 1851

Price Complete, with No. 43 Pen, \$12.00

- No. 1850—Metal-Ebony Green Finish, with Yellow equipment.
- No. 1851—Metal-Statuary Bronze Finish, with M-Red equipment.
- No. 1852—Metal-Golden Bronze Finish, with M-Green equipment.
- No. 1853—Metal-English Silver Finish, with Black equipment.

Size of Base 6½x4 in.

Dipaday Desk Sets offer a wide selection of bases and color combinations, appealing to the eye and appropriate to grace the finest desk in the office—an ornament in any home. A set to satisfy the taste, personality and purse of all classes of buyers.

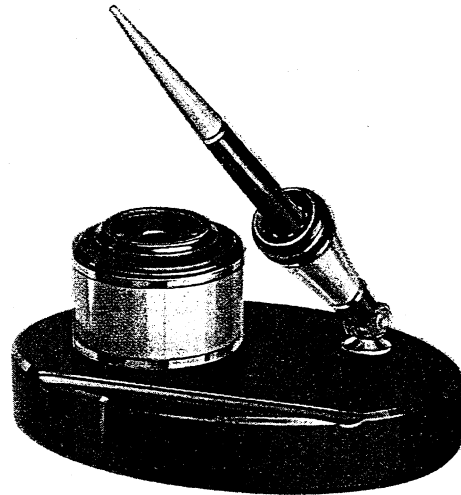

Above Illustrates No. 1861

Price Complete, with No. 43 Pen, \$17.00

- No. 1860—Emeraline Glass with Black equipment.
- No. 1861—Black Glass with Yellow equipment.
- No. 1862—Portoro Marble with M-Orange equipment.
- No. 1863—Genuine Onyx with M-Green equipment.
- No. 1864—Benou Jaune Marble with M-Red equipment.
- No. 1865—Bois Jourdan Marble with Red equipment.

Size of Base 6x4 in.

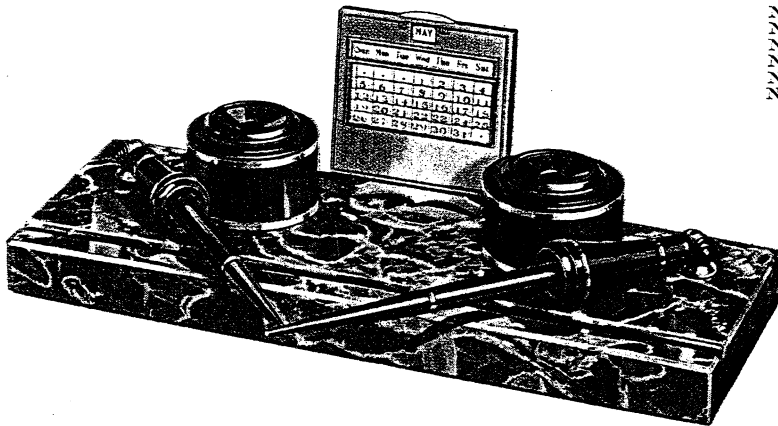

Above Illustrates No. 1992

Price Complete, with Two No. 43 Pens, \$35.00

- No. 1990—Emeraline Glass with Green equipment.
- No. 1991—Black Glass with M-Red equipment.
- No. 1992—Portoro Marble with Black equipment.
- No. 1993—Genuine Onyx with M-Green equipment.
- No. 1994—Benou Jaune Marble with M-Orange equipment.
- No. 1995—Bois Jourdan Marble with M-Red equipment.

Size of Base 12x4½ in.

Notice

Nos. 1990 to 1995, inclusive, illustrated on the left may be ordered without the gold plated perpetual calendars, deducting \$4.00 from the price of the set.

All Dipaday Desk Sets are priced complete with No. 43 pens and ornaments or trophies as illustrated. Choice of medium, fine, extra fine or stub points. If manifold points are specified add 50 cents extra for each pen.

Dipaday Desk Sets

Effectually Eliminate All Writing Troubles

PRICES ONLY SET
200
SUPPLEMENT PART 1

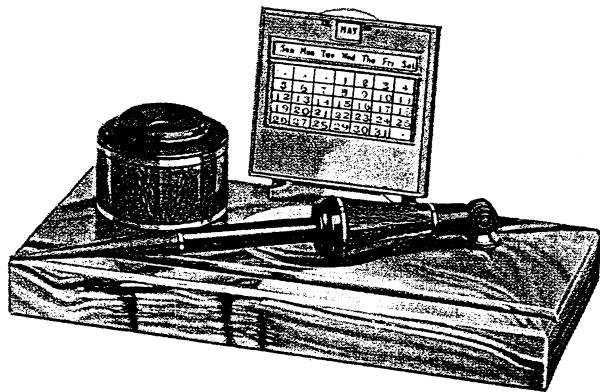

Above Illustrates No. 1983

Price Complete, with No. 43 Pen, \$23.50

- No. 1980—Emeraline Glass with Green equipment.
 - No. 1981—Black Glass with Red equipment.
 - No. 1982—Portoro Marble with M-Red equipment.
 - No. 1983—Genuine Onyx with M-Green equipment.
 - No. 1984—Benou Jaune Marble with M-Orange equipment.
 - No. 1985—Bois Jourdan Marble with Red equipment.
- Size of Base 9x4½ in.

Choice of Nine Colors

The No. 73 Inkstands and Adjustable Swivel Sockets are furnished in the following colors—

Red, green, blue, orange, black, yellow, mottled red, mottled green and mottled orange.

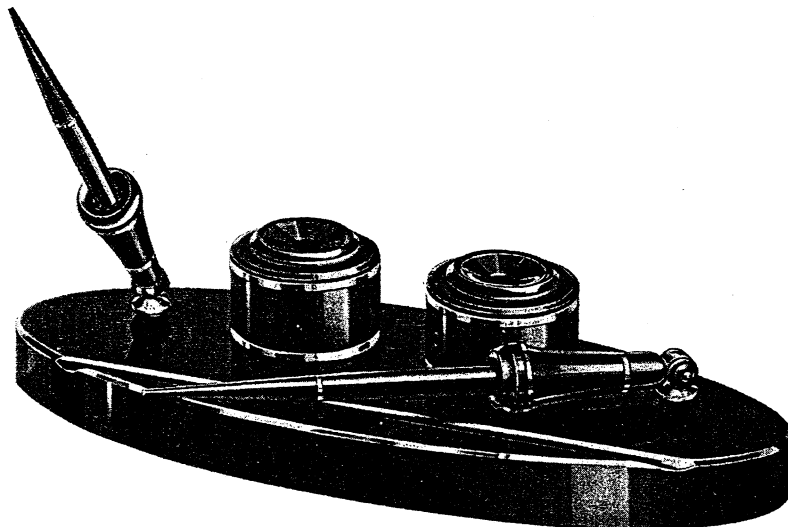

Above Illustrates No. 1891

Price Complete, with Two No. 43 Pens, \$33.00

- No. 1890—Emeraline Glass with Black equipment.
 - No. 1891—Black Glass with Black equipment.
 - No. 1892—Portoro Marble with M-Red equipment.
 - No. 1893—Genuine Onyx with Black equipment.
 - No. 1894—Benou Jaune Marble with M-Green equipment.
 - No. 1895—Bois Jourdan Marble with Black equipment.
- Size of Base 12x4½ in.

Nos. 1980 to 1985 inclusive, may be ordered without Gold Plated Calendars, deducting \$4.00 from the price of the set.

Adjustable in Every Sense of the Word

The new Sengbusch Socket may be adjusted to any angle, allowing a free swing to any position in any direction or it will also lie flat. There is no fixed position, but it will always stay where it is put. Holds the pen firmly, but releases easily without binding when pen is lifted.

The socket is also adjustable to fit the variation in size of pen barrels, quickly accomplished by turning the socket sleeve. Proper adjustment will exclude air from the pen point chamber and keep the point moist for instant service.



Above Illustrates No. 1974

Price Complete, with No. 43 Pen, \$16.00

- No. 1970—Emeraline Glass with Green equipment.
 - No. 1971—Black Glass with M-Red equipment.
 - No. 1972—Portoro Marble with M-Orange equipment.
 - No. 1973—Genuine Onyx with M-Green equipment.
 - No. 1974—Benou Jaune Marble with Orange equipment.
 - No. 1975—Bois Jourdan Marble with M-Red equipment.
- Size of Base 6x4½ in.

The No. 73 Inkstands and Adjustable Swivel Sockets are interchangeable from one base to another, therefore, a wide range of color combinations is possible.

Dipaday Desk Sets



PRICES CHANGED
SEE
SUPPLEMENT PAGE 5 A.

With Sport or Athletic Trophies



Golfer

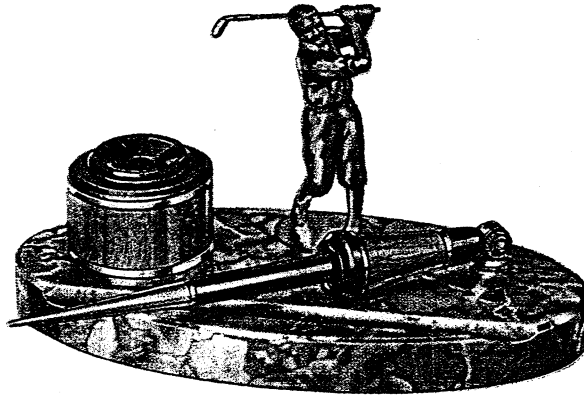

Above Illustrates No. 1874

Price Complete, with No. 43 Pen, \$26.50

- No. 1870—Emeraldine Glass with Green equipment.
 - No. 1871—Black Glass with Yellow equipment.
 - No. 1872—Portoro Marble with M-Red equipment.
 - No. 1873—Genuine Onyx with Orange equipment.
 - No. 1874—Benou Jaune Marble with M-Orange equipment.
 - No. 1875—Bois Jourdan Marble with Blue equipment.
- Size of Base 9x4 1/2 in.

Choice of Trophies—Golden Bronze Finish
Golfer, Runner, Swimmer, Tennis Player, Ball Player,
Shriner, Lady Golfer and Lady Tennis Player.



Lady Golfer



Runner

Dipaday Desk Sets equipped with sport or athletic trophies are not only beautiful and practical, but offer a new market and outlet for the dealer. Clubs, colleges, high schools, etc., favor them as awards for athletic merit.



Ball Player

They also appeal to the sport enthusiast for use on his or her individual desk.



Tennis Player

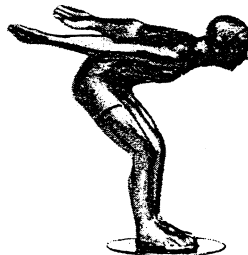

Swimmer



Shriner



Lady Tennis Player

Dipaday Desk Sets may also be ordered without trophies. Deduct \$5.00 from price listed.

Sengbusch

Dipaday Desk Sets

With Ornaments

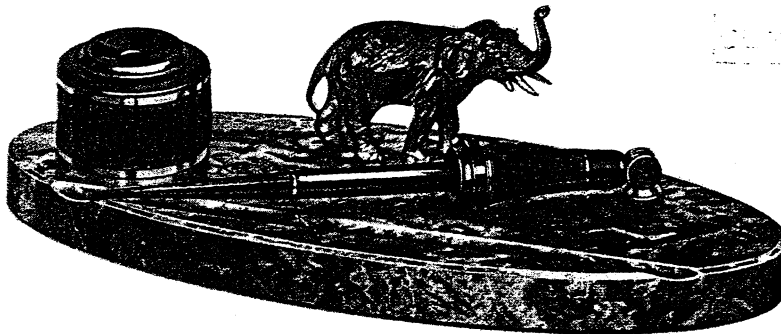

Above illustrates No. 1885

Price Complete, with No. 43 Pen, \$29.50

- No. 1880—Emeraline Glass with Black equipment.
 - No. 1881—Black Glass with Green equipment.
 - No. 1882—Portoro Marble with M-Red equipment.
 - No. 1883—Genuine Onyx with Blue equipment.
 - No. 1884—Benou Jaune Marble with M-Orange equipment.
 - No. 1885—Bois Jourdan Marble with M-Red equipment.
- Size of Base 12x4½ in.

Choice of Lion, Police Dog or Elephant Ornament

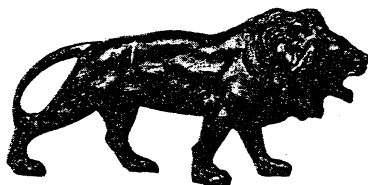

Lion
Stevens Bronze Finish

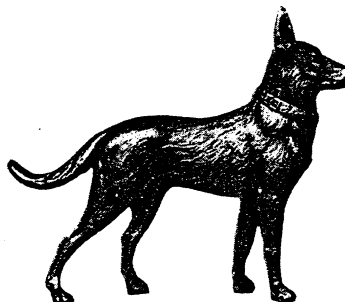

Police Dog
Golden Bronze Finish

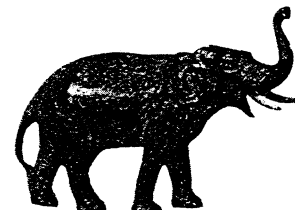

Elephant
Verde Green Bronze Finish

Above Dipaday Desk Sets may also be ordered without ornaments. Deduct \$5.00 from price listed.

Sengbusch Inkstand Sets and Gold Plated Perpetual Calendars

For the Office or Home

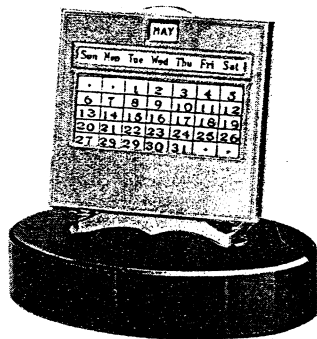

Price Complete, \$7.00

- No. 830—Emeraline Glass
 - No. 831—Black Glass
 - No. 832—Portoro Marble
 - No. 833—Genuine Onyx
 - No. 834—Benou Jaune Marble
 - No. 835—Bois Jourdan Marble
- Size of Base 4½x2¾ in.

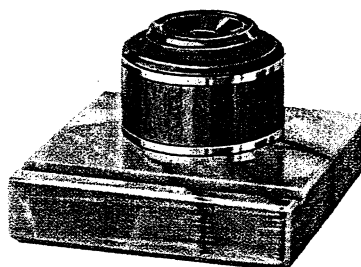

Price Complete, \$6.00

- No. 160—Emeraline Glass
 - No. 161—Black Glass
 - No. 162—Portoro Marble
 - No. 163—Genuine Onyx
 - No. 164—Benou Jaune Marble
 - No. 165—Bois Jourdan Marble
- Size of Base 4x4 in.

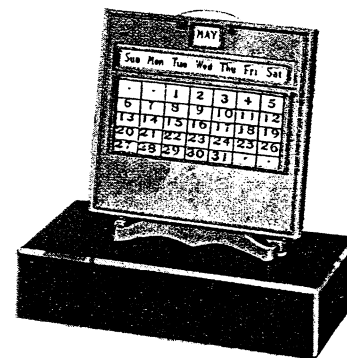

Price Complete, \$6.00

- No. 820—Emeraline Glass
 - No. 821—Black Glass
 - No. 822—Portoro Marble
 - No. 823—Genuine Onyx
 - No. 824—Benou Jaune Marble
 - No. 825—Bois Jourdan Marble
- Size of Base 4¼x2¼ in.

Calendars require date changing only once a month—quickly accomplished by a slide shift.

Sengbusch

Dipaday Desk Sets



ORDERED THROUGH
THE
IMPLEMENT CO. SEE

The Greatest Desk Set Value of Them All

Combination Sets of the Sengbusch Self-Closing Inkstand, Dipaday Pen, Adjustable Socket and attractive Durez Base. Equipped with the latest model all hard rubber inkstand—air tight, dust proof and non-evaporating. Instantly ready and always supplying clean, fresh ink to the pen, so essential for neat, efficient office work.

The Adjustable Socket holds the pen securely in an air-tight compartment which keeps the point moist and ready for instant use.

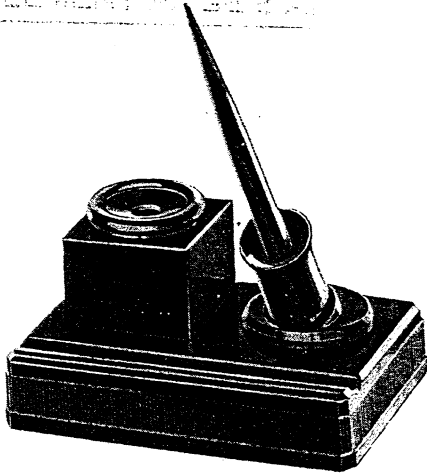

Price Complete, with No. 40 Pen, \$6.50

- No. 171—Black Finish Durez Base
 - No. 172—Green Finish Durez Base
 - No. 173—Mahogany Finish Durez Base
 - No. 174—Walnut Finish Durez Base
- Size 5 1/4 x 3 1/2 in.

Choice of Medium, Fine, Extra Fine or Stub Points.

All Manifold Points, 50 cents extra

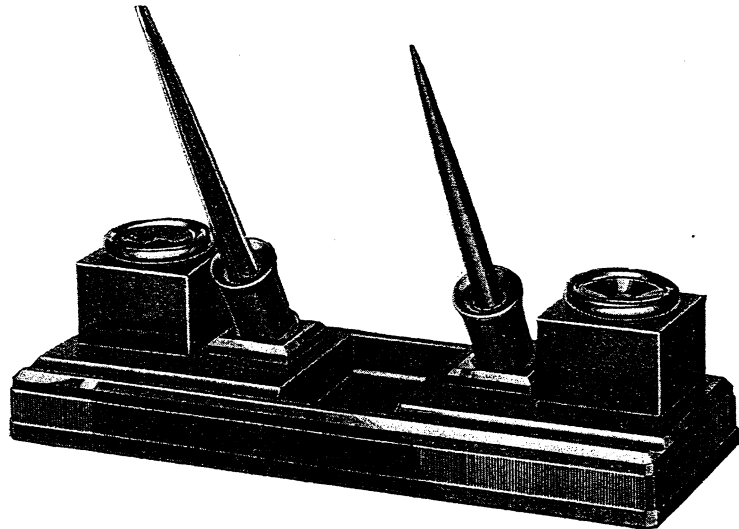

Price Complete, with Two No. 40 Dipaday Pens, \$13.00

- No. 191—Black Finish Durez Base
 - No. 192—Green Finish Durez Base
 - No. 193—Mahogany Finish Durez Base
 - No. 194—Walnut Finish Durez Base
- Size 10 1/2 x 3 3/8 in.

Sengbusch Adjustable Pen Sockets

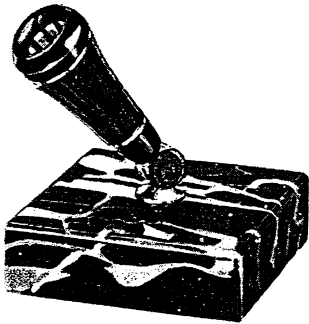

Above Illustrates No. 32
Price Complete, \$5.00

- No. 30—Emeraline Glass 3 in. square.
- No. 31—Black Glass 3 in. square.
- No. 32—Portoro Marble 3 in. square.
- No. 33—Genuine Onyx 3 in. square.
- No. 34—Benou Jaune Marble 3 in. square.
- No. 35—Bois Jourdan Marble 3 in. square.

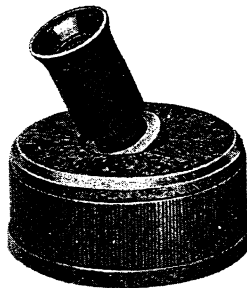

Above Illustrates No. 10 Black
Price Complete, \$2.00

- | | |
|----------------|-----------------|
| 3 in. Square | 3 in. Round |
| No. 1—Black | No. 10—Black |
| No. 2—Green | No. 11—Green |
| No. 3—Mahogany | No. 12—Mahogany |
| No. 4—Walnut | No. 13—Walnut |
| No. 5—Brown | No. 14—Brown |



Above Illustrates No. 20 Black
Price Complete, \$3.00

The No. 20 Socket may be used with Sengbusch Bases having 2 1/4 in. diameter receptacles for Nos. 56, 57 or 60 Inkstands.

The No. 26 Socket is used with Super-Colonial Sets on Page 23.
Price Complete, \$5.00.

Adjustable Swivel Sockets Nos. 20, 26, 30, to 35 inclusive are furnished in nine colors. Red, Green, Blue, Orange, Black, Yellow, Mottled Red, Mottled Green and Mottled Orange.

Supplement No. 1 to Sengbusch Catalog No. 22

Price changes and new additions

Effective July 1, 1930

Price Changes Page 4

Catalog No.	New Price
Nos. 1850, 1851, 1852, 1853.....	\$12.50
Nos. 1860, 1861, 1862, 1863, 1864, 1865.....	17.50
Nos. 1990, 1991, 1992, 1993, 1994, 1995.....	36.00

Price Changes Page 5

Nos. 1980, 1981, 1982, 1983, 1984, 1985.....	24.50
Nos. 1970, 1971, 1972, 1973, 1974, 1975.....	16.50
Nos. 1890, 1891, 1892, 1893, 1894, 1895.....	34.00

Price Changes Page 6

Nos. 1870, 1871, 1872, 1873, 1874, 1875.....	27.00
--	-------

Price Changes Page 7

No. 1880, 1881, 1882, 1883, 1884, 1885.....	30.00
---	-------

Price Changes Page 8

Nos. 171, 172, 173, 174.....	7.00
Nos. 191, 192, 193, 194.....	14.00
Nos. 30, 31, 32, 33, 34, 35.....	Discontinued
Nos. 1, 2, 3, 4, 5.....	Discontinued
Nos. 10, 11, 12, 13, 14.....	Discontinued

New Hard Rubber Inkstands

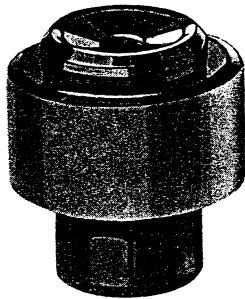

No. 74—Hard Rubber Price Each \$1.75

The above Inkstand No. 74 is illustrated in Dipaday Set No. 306 on next page. Dimensions same as Inkstand No. 73 illustrated on page 10, Catalog No. 22. Supplied in nine colors, same as No. 73, but without gold plated bands.

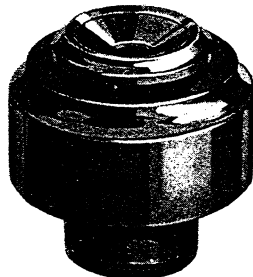

No. 75—Hard Rubber Price Each \$1.75

2½ in. Over-all Height.
 1½ in. Height above desk level.
 1¼ in. Height below desk level.
 2½ in. Diameter above desk level.
 1½ in. Diameter below desk level.

The above Inkstand No. 75 is illustrated in Dipaday Desk Sets Nos. 305 and 315 on next page. Extra large capacity. Supplied in black color only.

New Dipaday Accessories



No. 81 Socket, \$2.50
 with 3" round receptacle
 for No. 51 or No. 55 Inkstand
 With No. 40 Black Dipaday Pen, \$5.50

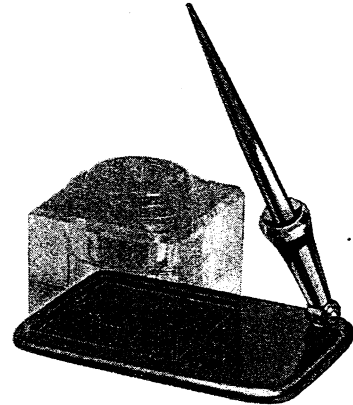

No. 82 Socket, \$2.50
 with 3" square receptacle
 for No. 52 or No. 53 Inkstand
 With No. 40 Black Dipaday Pen, \$5.50
 Nos. 81 and 82 Sockets
 Black, M-Red, M-Green, or M-Orange Colors

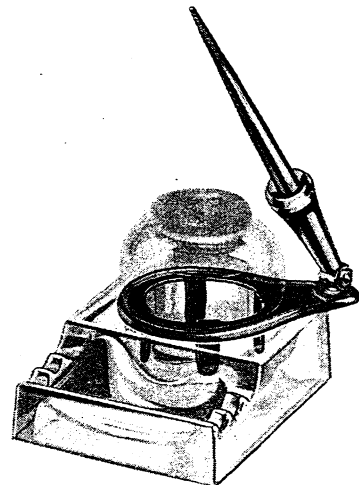

No. 86 Socket, \$2.00
 for Sengbusch Bases with 2½" Hole,
 for No. 56, No. 57 or No. 60 Inkstand
 With No. 40 Black Dipaday Pen, \$5.00

New Dipaday Desk Sets

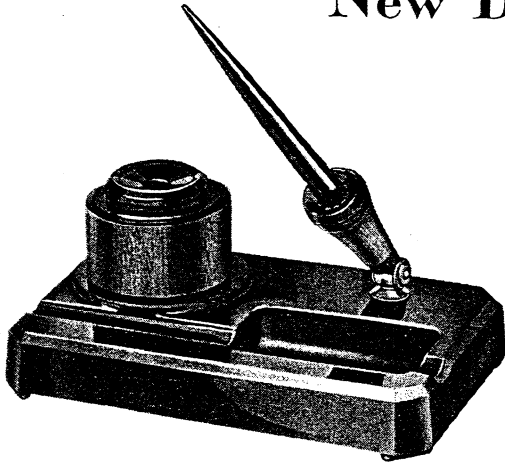

No. 306—Black Glass, Single Set.....\$ 8.50
 No. 307—Opal Glass, Single Set..... 8.50
 No. 316—Black Glass, Double Set..... 17.00
 No. 317—Opal Glass, Double Set..... 17.00
 Equipped with one No. 74 Inkstand, one swivel adjustable Socket and one No. 40 Dipaday Pen.

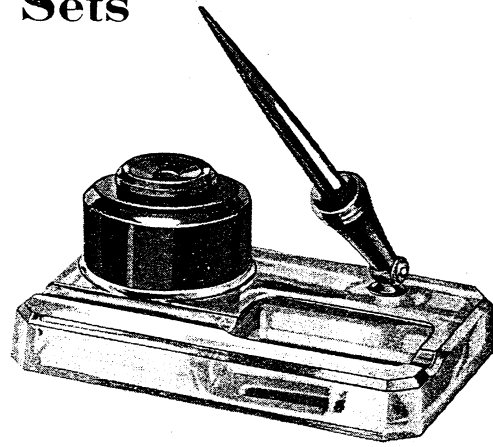

No. 305—Clear Glass Single Set.....\$7.50
 Equipped with one No. 75 hard rubber Inkstand, one swivel Socket and one No. 40 Dipaday Pen.

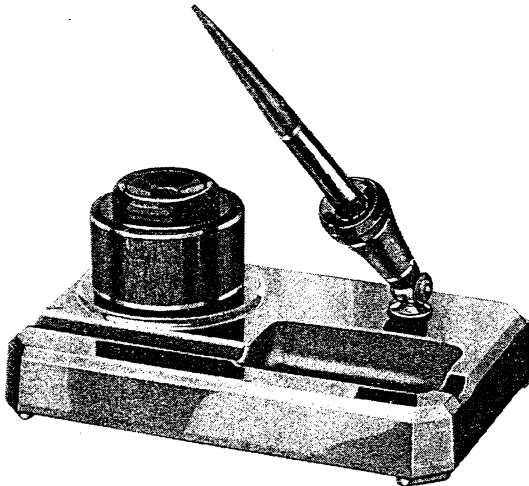

No. 308—Black Glass, Single Set.....\$10.50
 No. 309—Opal Glass, Single Set..... 10.50
 No. 318—Black Glass, Double Set..... 21.00
 No. 319—Opal Glass, Double Set..... 21.00
 Equipped with one No. 73 Inkstand, one swivel adjustable Socket and one No. 43 Dipaday Pen.

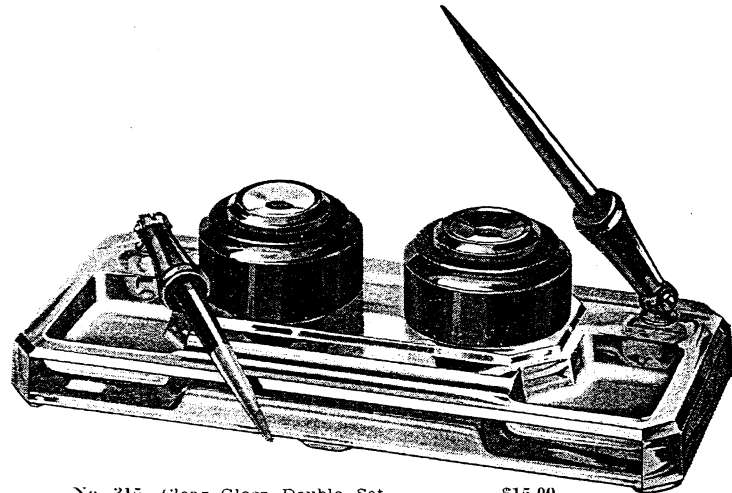

No. 315—Clear Glass Double Set.....\$15.00
 Equipped with two No. 75 hard rubber Inkstands, two swivel Sockets and two No. 40 Dipaday Pens.

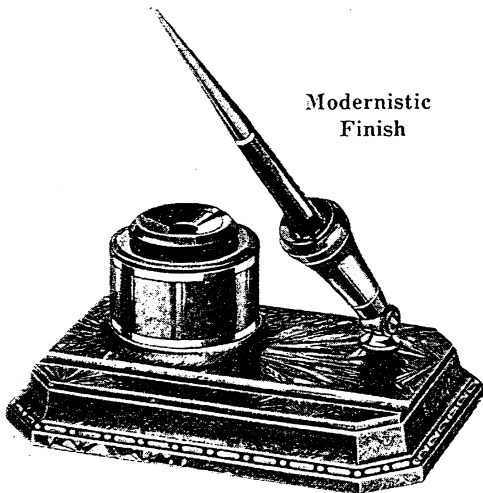

Modernistic
Finish

No. 1854—Verdi Copper\$13.50
 No. 1855—English Copper 13.50
 No. 1856—English Brass 13.50
 No. 1857—English Golden Bronze..... 13.50
 Equipped with one No. 73 Inkstand, one swivel adjustable Socket and one No. 43 Dipaday Pen.

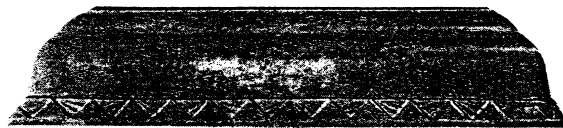

Sengbusch
Desk

Dipaday
Lamp

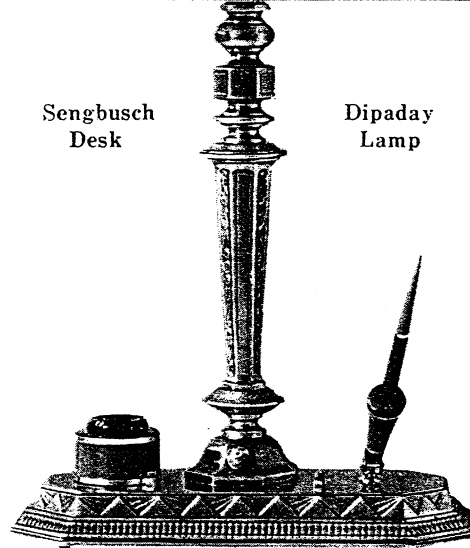

No. D-501—Genuine Cast Bronze.....\$75.00
 Equipped with one No. 73 Inkstand, one swivel adjustable Socket and one No. 43 Dipaday Pen.

Single Inkstands

Air-Tight—Dust-Proof—Non-Evaporating—Simple to Fill—Self-Adjusting—Instantly Ready

A Combination of Utility, Durability, Cleanliness and Economy

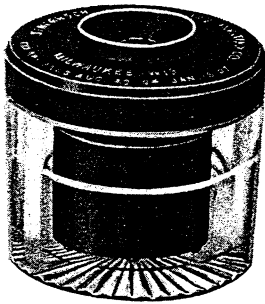

No. 51—Plain Glass, 3 in. diam. \$2.00
This style is made only in one number.
The top screws onto the glass.

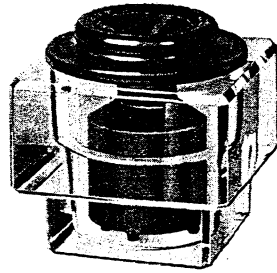

Cut Glass Square Countersunk Inkstands

No.	Dimensions	Price Each
No. 52M	3 in. Over-all height.	\$2.50
No. 52F	3 in. Height above desk level.	
	2 1/8 in. Height below desk level.	
	2 1/8 in. Square above desk level.	
	2 1/8 in. Square below desk level.	

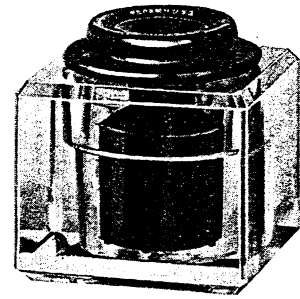

Cut Glass Square Countersunk Inkstands

No.	Dimensions	Price Each
No. 52	Cut Glass, 3 in. square	\$2.50
No. 53	Plain " 3 in. "	2.25
No. 54	Cut " 3 1/2 in. "	3.75
No. 54a	" 4 in. "	5.75

In all these numbers, also in No. 57, a hard rubber collar is permanently set into the glass and the top plugs into this collar.
No. 52 may be had cut down to either 2 1/2 inches, 2 3/4 inches, or 2 7/8 inches at 50 cents extra.

Home and Office Special

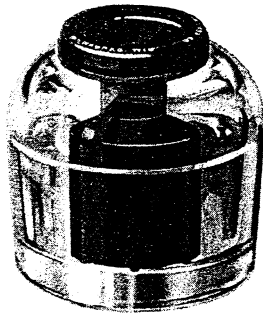

No. 55—Plain Glass, 3 in. diam. \$2.00
No. 61— " " 2 1/2 in. 2.00
These two numbers are made up as illustrated, the only difference being in their diameter. The height of both numbers is the same. The top plugs into the glass.

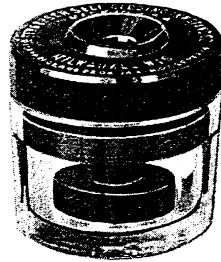

No. 62—Plain Glass, 2 1/2 in. diam. \$1.75

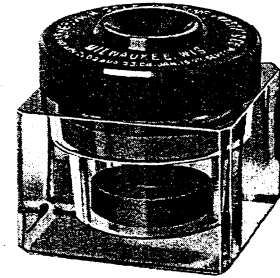

No. 63—Plain Glass, 2 1/2 in. sq. \$1.75
No. 64—Cut " 2 1/2 in. 2.00

These smaller inkstands possess the same Self-Closing features as all other "Sengbusch" inkstands, yet are constructed differently. In the regular "Sengbusch" commercial stands the hard rubber buoyant float is incased in a hard rubber casing commonly termed the "fountain." In the Nos. 62, 63 and 64 this same float operates in a glass sleeve set in a cork gasket. The Nos. 62, 63 and 64 are bought chiefly where space does not permit using the larger "Sengbusch" stands; otherwise the latter are preferred.

Countersunk Inkstands

These inkstands set into round hole in desk or in bases as shown on the following pages.

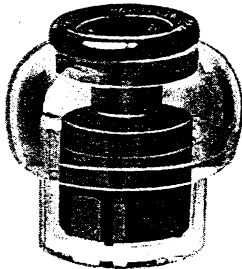

No. 56—Plain Glass, 2 3/4 in. diam. \$2.00
No. 60— " " 3 in. 2.00

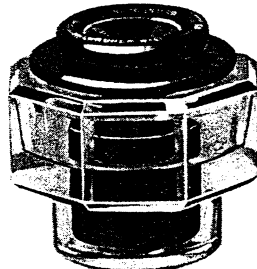

No. 57—Cut Glass, 3 in. Octagon. \$2.50
No. 57—Black " 2 3/4 in. " 3.00

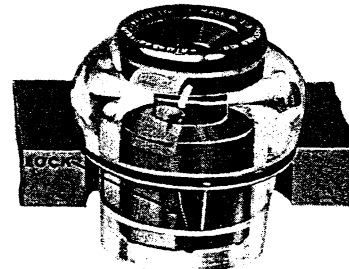

No. 58—Same as No. 56, with lock. \$2.25
No. 60— " " No. 60, " " 2.25

The "Lock Well"

Locks firmly into the desk and cannot be removed without the aid of a key.

On all Countersunk Inkstands the over-all height is 3 inches. The height of the part below the desk level is 1 1/4 inches on Nos. 56, 58 and 60, and 1 inch on No. 57. The diameter of the part below the desk level is 2 1/2 inches on all countersunk inkstands.

All single inkstands come with black caps unless otherwise ordered. Red caps may be had if specified.

Single Inkstands

All Hard Rubber Sengbusch Self-Closing Inkstands

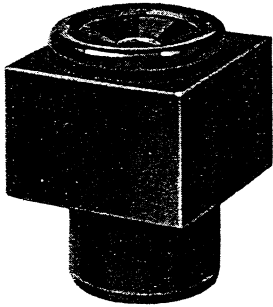

No. 70—Hard Rubber.....\$1.50

Price Each
 2 1/2 in. Over-all Height.
 1 13/16 in. Height above desk level.
 1 1/8 in. Height below desk level.
 2 in. Square above desk level.
 1 1/2 in. Diameter below desk level.

The above Inkstand No. 70 is illustrated in combination with Dipaday Desk Sets on page 8 of Catalog No. 22.

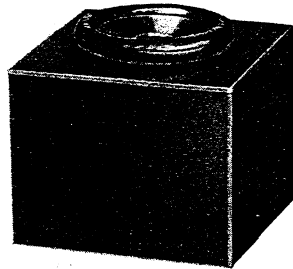

No. 72—Hard Rubber\$2.00

2 1/2 in. High.
 2 1/2 in. Square.

The above Inkstand No. 72 is intended for use on top of the desk, but can also be used with bases having a 2 1/2 inch receptacle.

Note:—The White Cut Glass and Pressed Glass Bases, page 25 of Catalog No. 22, also any Emeraline Base illustrated with No. 52 Cut Glass Inkstand, may be had at same prices with 2 1/2 in. square receptacles for No. 72 Inkstands.

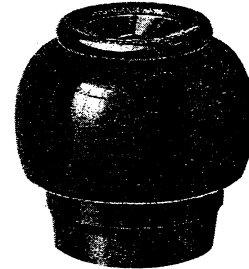

No. 76—Hard Rubber.....\$2.25

Price Each
 2 3/4 in. Over-all Height.
 1 13/16 in. Height above desk level.
 1 1/8 in. Height below desk level.
 2 1/4 in. Diameter above desk level.
 2 1/8 in. Diameter below desk level.

The above Inkstand No. 76 fits a 2 1/4 inch hole and bases intended for No. 56, No. 57 and No. 60 Glass Inkstands.

All single inkstands come with black caps unless otherwise ordered. Red caps may be had if specified.

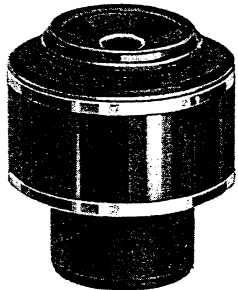

No. 73—Hard Rubber.....\$2.50

Price Each
 Choice of Colors as Listed.
 2 1/2 in. Over-all Height.
 1 13/16 in. Height above desk level.
 1 1/8 in. Height below desk level.
 2 1/4 in. Diameter above desk level.
 1 1/2 in. Diameter below desk level.

The above inkstand No. 73 is illustrated in various colors on pages 4, 5, 6 and 7, inclusive.

Notice

The No. 73 Inkstand, shown on the left, is supplied in the following colors, viz.: black, green, red, yellow, blue, orange, mottled red, mottled green and mottled orange. Be sure to specify color when ordering.

Illustrated in colors in combination with Dipaday Desk Sets on pages 4, 5, 6 and 7, inclusive.

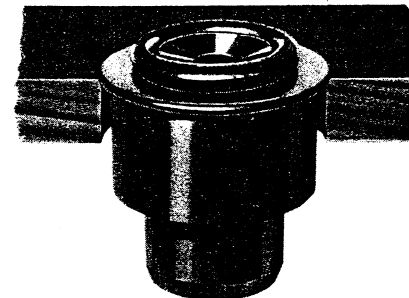

No. 71—Hard Rubber.....\$1.50

2 1/2 in. Over-all Height.
 3/8 in. Height above desk level.
 2 1/8 in. Height below desk level.
 2 1/8 in. Diameter below desk level.

The above Inkstand No. 71 is used chiefly where almost complete counter-sinking is required. Adapted for Hotel and School desks.

Price List for Parts

Separate parts may be purchased for all "Sengbusch" Inkstands, but the following must be complied with, viz.

If a certain rubber part is wanted, the old part should invariably be returned so that a new part may be selected which gauges accordingly.

If a glass part is wanted, return all the rubber parts, so that a new glass may be selected with which the rubber parts assemble correctly.

If a fountain requires a glass disc, mail in the fountain.

CAUTION: Parts for "Sengbusch" Inkstands should never be interchanged.

Hard Rubber Inkstands

No.	Body	Top	Center	Float	Fountain
70	\$.60	\$.25	\$.25	\$.40
71	.60	.25	.25	.40
72	1.10	.25	.25	.40
73	1.60	.25	.25	.40
76	1.00	.25	\$1.00

Glass Inkstands

No.	Glass	Top	Collar	Fountain	
51	\$.50	\$.50	...	\$1.00	
52	1.00	.25	\$0.25	1.00	
53	.75	.25	.25	1.00	
54	2.25	.25	.25	1.00	
54a	4.25	.25	.25	1.00	
55	.75	.25	...	1.00	
56	.75	.25	...	1.00	
57	1.00	.25	.25	1.00	
58	.75	.25	...	1.00	
60	.75	.25	...	1.00	
61	.75	.25	...	1.00	
No.	Glass	Top	Float	Center	Cork
62	\$.50	\$.50	\$.40	\$.30	\$.05
63	.50	.50	.40	.30	.05
64	.75	.50	.40	.30	.05

Rubber Washers

Nos. 51 and 62, 25 cents per dozen.

All others 50 cents per dozen.

Pin Cups

Cut Glass, 75 cents each. Pressed Glass, 25 cents each.

Sengbusch

No-Mar Rubber Base Sets



Bases Made of Flexible, Medium Hard, Colored Rubber. Cannot Scratch or Mar the Desk.

No-Mar Bases for No. 51 and No. 55 "Sengbusch" Inkstands

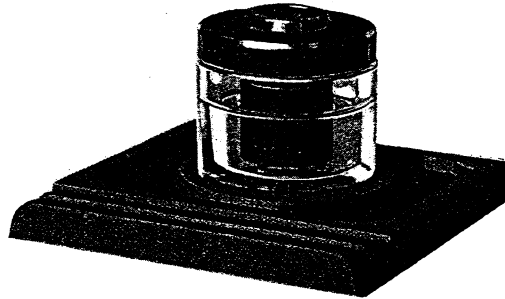

Above Illustrates No. 626 with No. 51

No. 624—Brown, for Single Desk, with one	No. 51 or	No. 55	Set	Base
No. 626—Green, " " " " " "	"	"	.. \$4.00	\$2.00
			.. 4.00	2.00

Size of Base $6\frac{1}{2} \times 6\frac{1}{2} \times \frac{1}{2}$ in.

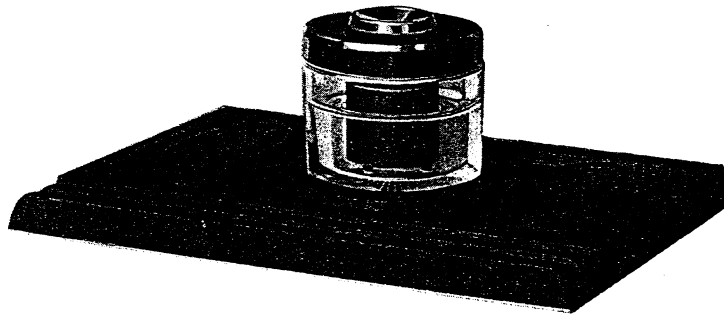

Above Illustrates No. 600 with No. 51

No. 600—Brown, for Single Desk, with one	No. 51 or	No. 55	Set	Base
No. 601—" " Double " " " "	"	"	.. \$5.00	\$3.00
No. 602—Green, " Single " " " "	"	"	.. 5.50	3.50
No. 603—" " Double " " " "	"	"	.. 5.00	3.00
			.. 5.50	3.50

Size of Single Desk Base $10\frac{1}{4} \times 7\frac{1}{2} \times \frac{1}{2}$ in.
 Size of Double Desk Base $10\frac{1}{4} \times 8\frac{3}{4} \times \frac{1}{2}$ in.

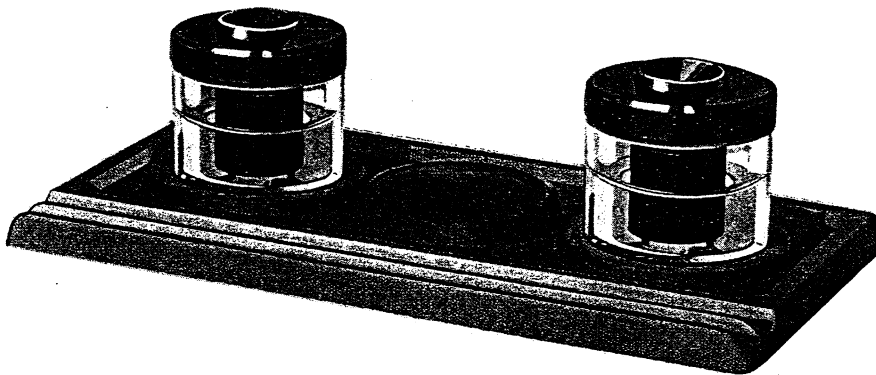

Above Illustrates No. 606 with Two No. 51

No. 604—Brown, for Single Desk, with two	No. 51 or	No. 55	Set	Base
No. 605—" " Double " " " "	"	"	.. \$7.50	\$3.50
No. 606—Green, " Single " " " "	"	"	.. 8.00	4.00
No. 607—" " Double " " " "	"	"	.. 7.50	3.50
			.. 8.00	4.00

Size of Single Desk Base $13\frac{1}{4} \times 7\frac{1}{2} \times \frac{1}{2}$ in.
 Size of Double Desk Base $13\frac{1}{4} \times 8\frac{3}{4} \times \frac{1}{2}$ in.

As the Nos. 51 and 55 Inkstands are the same diameter, the same Bases apply for both Inkstands. When ordering Sets, specify whether No. 51 or No. 55 Inkstand is wanted.

Sengbusch

No-Mar Rubber Base Sets



No-Mar Bases for No. 52 and No. 53 "Sengbusch" Inkstands

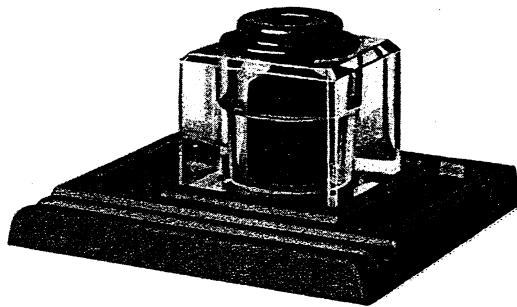

Above Illustrates No. 630 with No. 52

	Set	Base
No. 628—Brown, for Single Desk, with one No. 52.....	\$4.50	\$2.00
No. 630—Green, "	4.50	2.00

Size of Base $6\frac{1}{2} \times 6\frac{1}{2} \times \frac{1}{8}$ in.

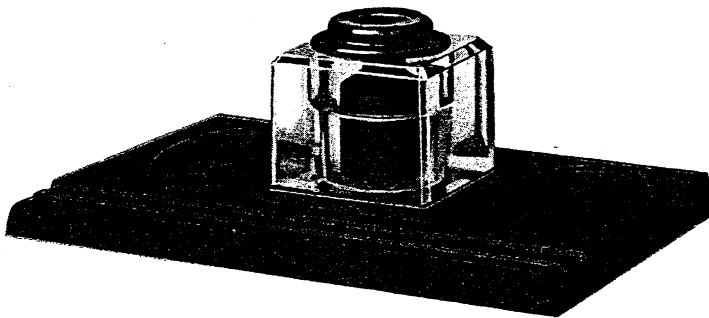

Above Illustrates No. 608 with No. 52

	Set	Base
No. 608—Brown, for Single Desk, with one No. 52.....	\$5.50	\$3.00
No. 609— " " Double " " " " " " " " " " " " " " " "	6.00	3.50
No. 610—Green, " Single " " " " " " " " " " " " " " "	5.50	3.00
No. 611— " " Double " " " " " " " " " " " " " " "	6.00	3.50

Size of Single Desk Base $10\frac{1}{4} \times 7\frac{1}{2} \times \frac{1}{8}$ in.
 Size of Double Desk Base $10\frac{1}{4} \times 8\frac{3}{4} \times \frac{1}{8}$ in.

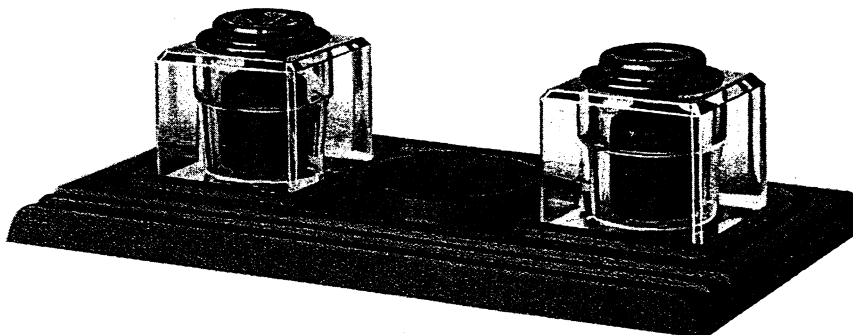

Above Illustrates No. 614 with Two No. 52

	Set	Base
No. 612—Brown, for Single Desk, with two No. 52.....	\$8.50	\$3.50
No. 613— " " Double " " " " " " " " " " " " " " "	9.00	4.00
No. 614—Green, " Single " " " " " " " " " " " " " " "	8.50	3.50
No. 615— " " Double " " " " " " " " " " " " " " "	9.00	4.00

Size of Single Desk Base $13\frac{1}{4} \times 7\frac{1}{2} \times \frac{1}{8}$ in.
 Size of Double Desk Base $13\frac{1}{4} \times 8\frac{3}{4} \times \frac{1}{8}$ in.

NOTE—Wherever No. 52 is illustrated and listed with Bases, No. 53 Plain Glass may be substituted at 25 cents less for each Well.

Emeraline Base Sets



Selected Quality Plate Glass—Hand Cut and Highly Polished

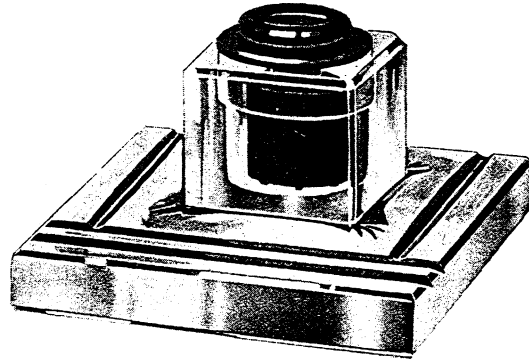

Above Illustrates No. 200

Single Desk			Double Desk		
No.	Thickness	Price	No.	Thickness	Price
No. 200	1 in. thick with one No. 52...	\$8.50	No. 201	1 in. thick with one No. 52...	\$11.00
No. 204	½ in. " " " No. 52...	6.50	No. 205	½ in. " " " No. 52...	8.50
Size of Base 6½x6½ in.			Size of Base 7x9 in.		

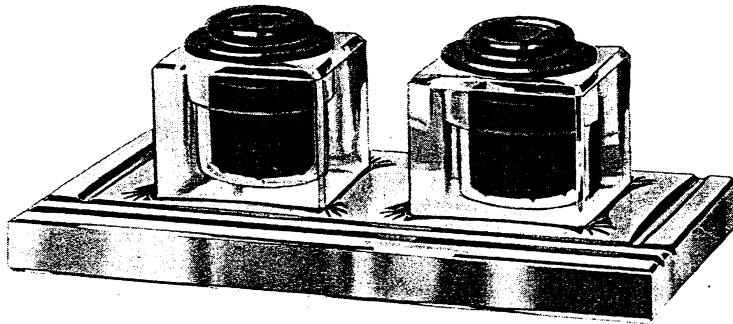

Above Illustrates No. 210

Single Desk			Double Desk		
No.	Thickness	Price	No.	Thickness	Price
No. 210	1 in. thick with two No. 52...	\$15.50	No. 211	1 in. thick with two No. 52...	\$18.00
No. 214	½ in. " " " No. 52...	12.00	No. 215	½ in. " " " No. 52...	14.50
Size of Base 6x11 in.			Size of Base 8x11 in.		

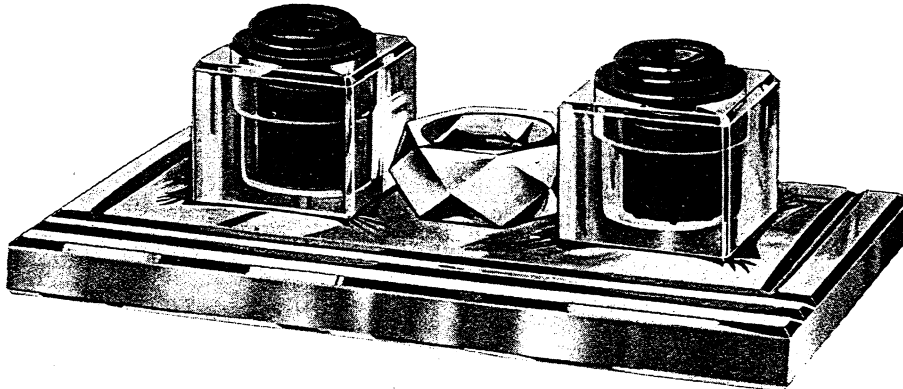

Above Illustrates No. 220

Single Desk			Double Desk		
No.	Thickness	Price	No.	Thickness	Price
*No. 220	1 in. thick with two No. 52...	\$18.00	*No. 221	1 in. thick with two No. 52...	\$21.00
*No. 224	½ in. " " " No. 52...	14.00	*No. 225	½ in. " " " No. 52...	16.00
Size of Base 6½x12 in.			Size of Base 9x13¼ in.		

*Price includes Cut Glass Pin Cup.

"Sengbusch" Emeraline Base Sets are very attractive, and add materially to the effect of a well-equipped office. No first-class office equipment is complete without them.

Felt Mats with Pinked Edges may be had in Green, Brown and Maroon colors.

Emeraline Base Sets



Selected Quality Plate Glass—Hand Cut and Highly Polished

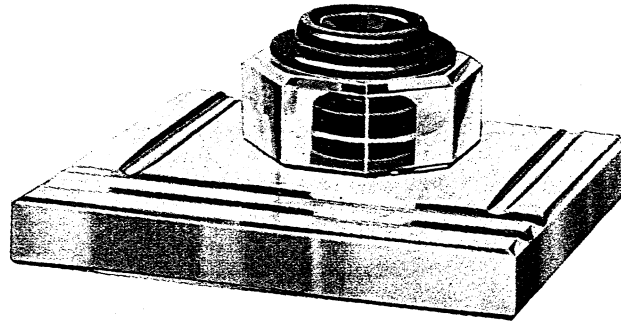

Above Illustrates No. 202

Single Desk No. 202—1 in. thick with one No. 57.....	Set Complete	Base	Felt Mat
	Without Felt Mat	Only	for Base
Size of Base 6½x6½ in.	\$8.50	\$6.00	\$.50

Double Desk No. 203—1 in. thick with one No. 57.....	Set Complete	Base	Felt Mat
	Without Felt Mat	Only	for Base
Size of Base 7x9 in.	\$11.00	\$8.50	\$.70

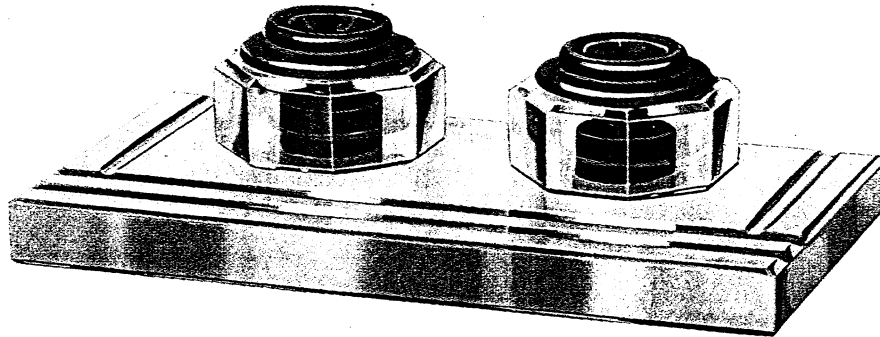

Above Illustrates No. 212

Single Desk No. 212—1 in. thick with two No. 57.....	Set Complete	Base	Felt Mat
	Without Felt Mat	Only	for Base
Size of Base 6x11 in.	\$16.00	\$11.00	\$.75

Double Desk No. 213—1 in. thick with two No. 57.....	Set Complete	Base	Felt Mat
	Without Felt Mat	Only	for Base
Size of Base 8x11 in.	\$18.50	\$13.50	\$.90

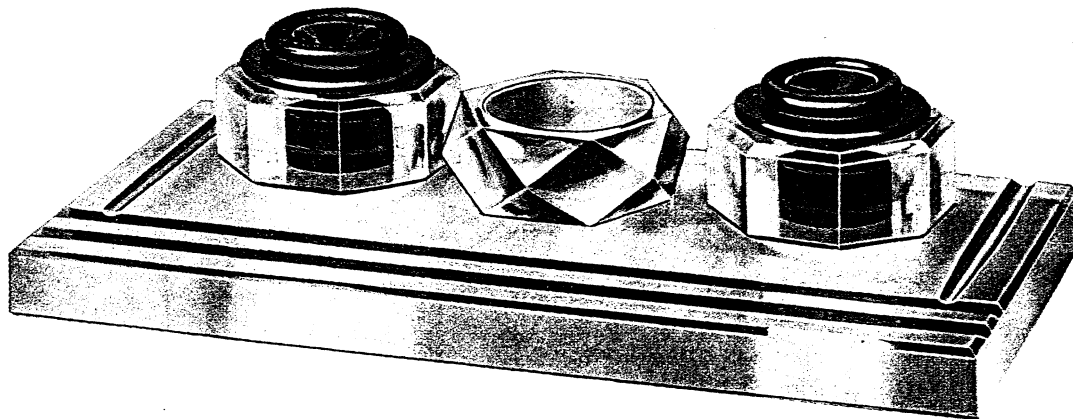

Above Illustrates No. 222

Single Desk *No. 222—1 in. thick with two No. 57.....	Set Complete	Base	Felt Mat
	Without Felt Mat	Only	for Base
Size of Base 6½x12 in.	\$18.50	\$13.50	\$.90

Double Desk *No. 223—1 in. thick with two No. 57.....	Set Complete	Base	Felt Mat
	Without Felt Mat	Only	for Base
Size of Base 9x13¼ in.	\$21.50	\$16.50	\$1.20

*Price includes Cut Glass Pin Cup.

The six styles listed on this page can also be furnished in Marble, Onyx or Black Glass Bases. Write for prices.

Jaybird

Emeraline Base Sets



Oval Designs with Two Oval Scooped Pin Cups in Each Base

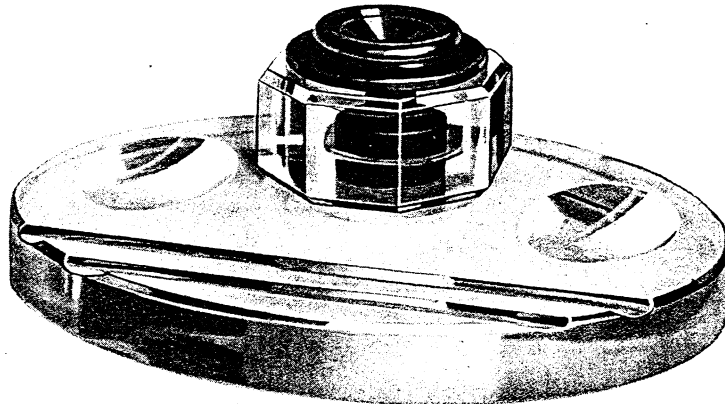

Above Illustrates No. 206

	Set Complete Without Felt Mat	Base Only	Felt Mat for Base		Set Complete Without Felt Mat	Base Only	Felt Mat for Base
Single Desk No. 206—1 in. thick with one No. 57....	\$11.50	\$ 9.00	\$.70		Double Desk No. 207—1 in. thick with one No. 57....	\$14.50	\$12.00
Size of Base 7x9 in.					Size of Base 7¼x9½ in.		\$.85

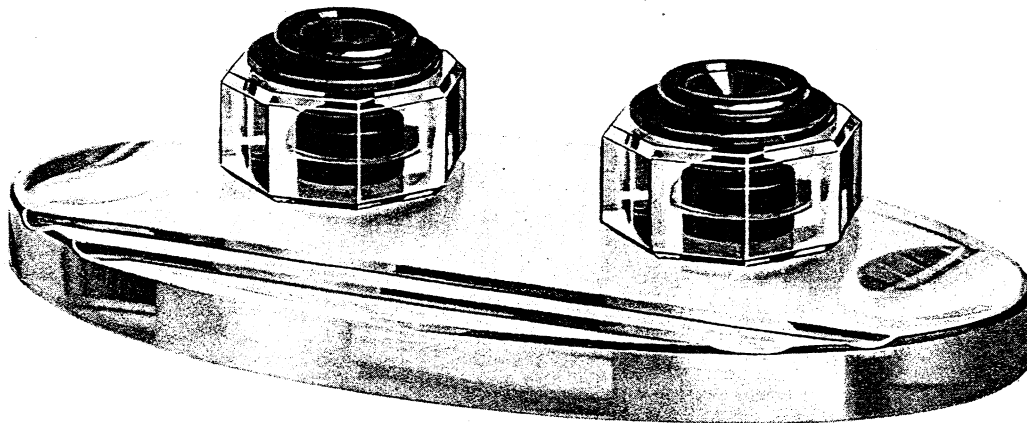

Above Illustrates No. 216

	Set Complete Without Felt Mat	Base Only	Felt Mat for Base		Set Complete Without Felt Mat	Base Only	Felt Mat for Base
Single Desk No. 216—1 in thick with two No. 57....	\$19.50	\$14.50	\$1.10		Double Desk No. 217—1 in. thick with two No. 57....	\$22.00	\$17.00
Size of Base 7x13½ in.					Size of Base 9x13½ in.		\$1.20

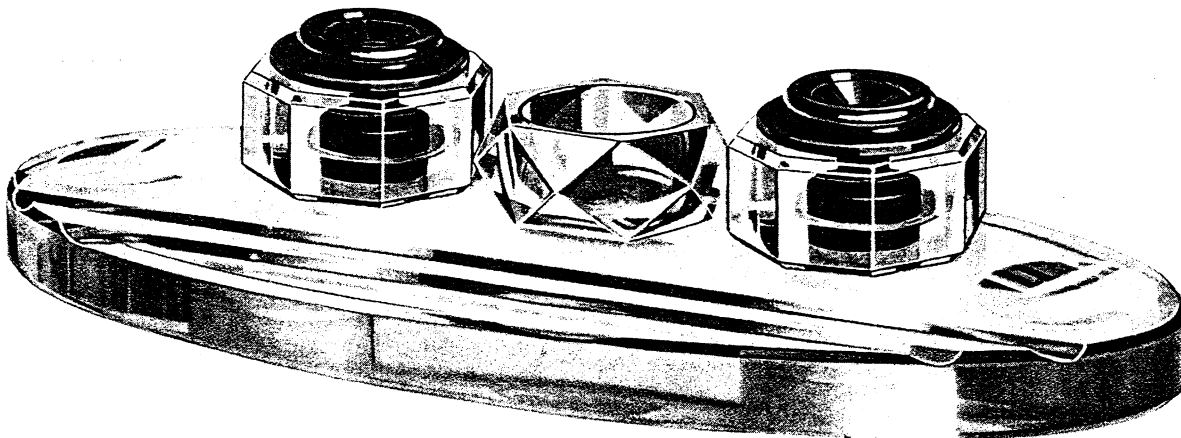

Above Illustrates No. 226

	Set Complete Without Felt Mat	Base Only	Felt Mat for Base		Set Complete Without Felt Mat	Base Only	Felt Mat for Base
Single Desk *No. 226—1 in. thick with two No. 57....	\$22.50	\$17.50	\$1.20		Double Desk *No. 227—1 in. thick with two No. 57....	\$26.50	\$21.50
Size of Base 7x16 in.					Size of Base 9½x16 in.		\$1.50

*Price includes Cut Glass Pin Cup.

Imperial

Emeraline Base Sets

Practical and Popular Emeraline Base Sets

Especially adapted for Bank Counters, Low Roll-top Desks, etc., where a 4½-inch wide Base is an advantage. Also very applicable for Double Desk use.

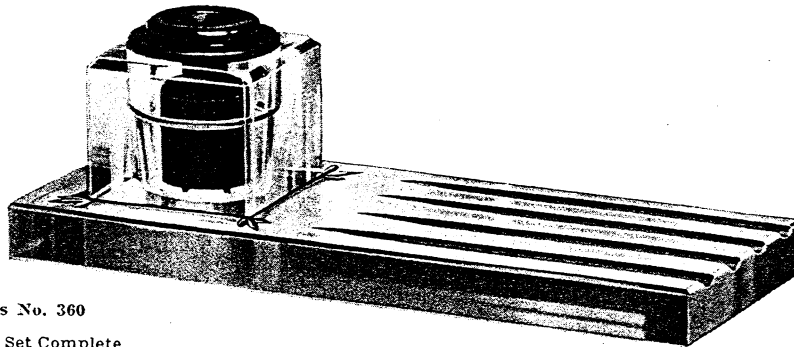

Above Illustrates No. 360

	Set Complete Without Felt Mat	Base Only	Felt Mat for Base
No. 360—1 in. thick with one No. 52...	\$9.00	\$ 6.50	\$.65
No. 362—½ in. " " " No. 52...	7.50	5.00	.65

Size of Base 12x4½ in.

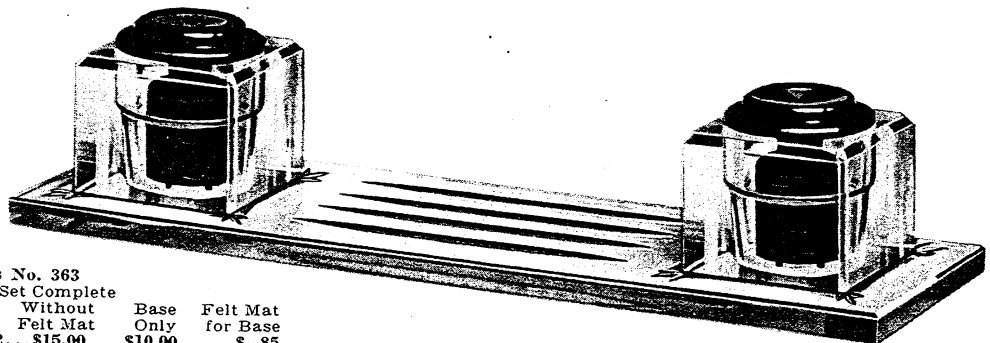

Above Illustrates No. 363

	Set Complete Without Felt Mat	Base Only	Felt Mat for Base
No. 361—1 in. thick with two No. 52...	\$15.00	\$10.00	\$.85
No. 363—½ in. " " " No. 52...	13.00	8.00	.85

Size of Base 16x4½ in.

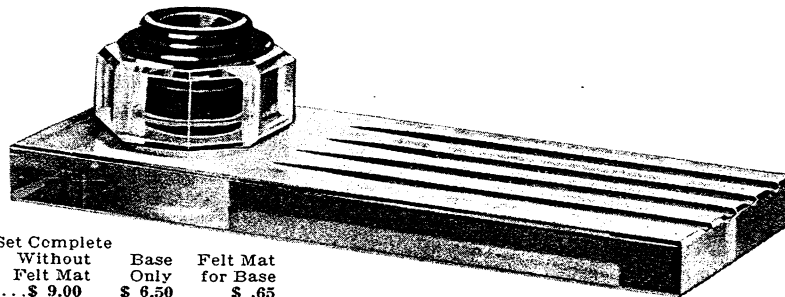

	Set Complete Without Felt Mat	Base Only	Felt Mat for Base
No. 364—1 in. thick with one No. 57....	\$ 9.00	\$ 6.50	\$.65

Size of Base 12x4½ in.

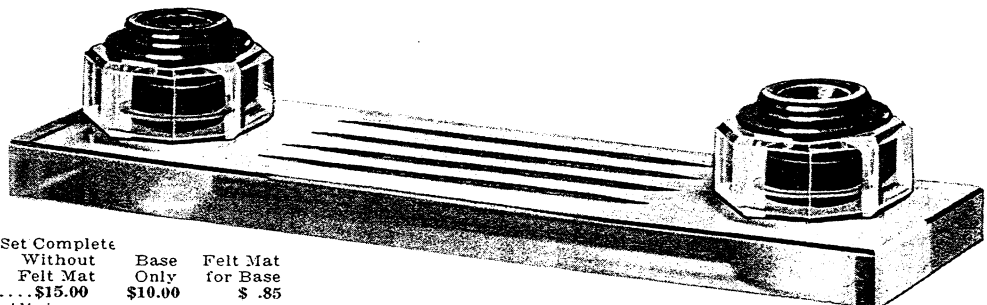

	Set Complete Without Felt Mat	Base Only	Felt Mat for Base
No. 366—1 in. thick with two No. 57....	\$15.00	\$10.00	\$.85

Size of Base 16x4½ in.

Nos. 364 and 366 can be furnished with Black Polished Plate Glass Bases and Black Glass Inkstands at 50 cents additional for each inkstand.

Emeraline Base Sets



Emeraline Bases for No. 51 and No. 55 "Sengbusch" Inkstands

Bases made of ½-inch Thick Plate Glass.

As the Nos. 51 and 55 Inkstands are the same diameter, the same Bases apply for both Inkstands.
When ordering Sets, specify whether No. 51 or No. 55 Inkstand is wanted.

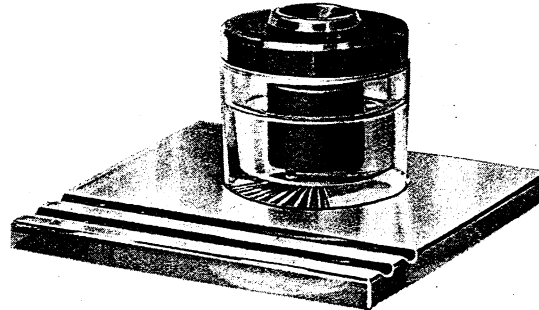

Above Illustrates No. 370, with No. 51

	Set Complete	Without Felt Mat	Base Only	Felt Mat for Base
No. 370—Single Desk Base, Size 6½ x 6½ in., with one No. 51 or No. 55..	\$ 6.00	\$ 4.00		\$.50
No. 372— " " " " 6 x11 in., " two No. 51 " No. 55..	11.00	7.00		.75
*No. 374— " " " " 6½x12 in., " two No. 51 " No. 55..	13.00	9.00		.90

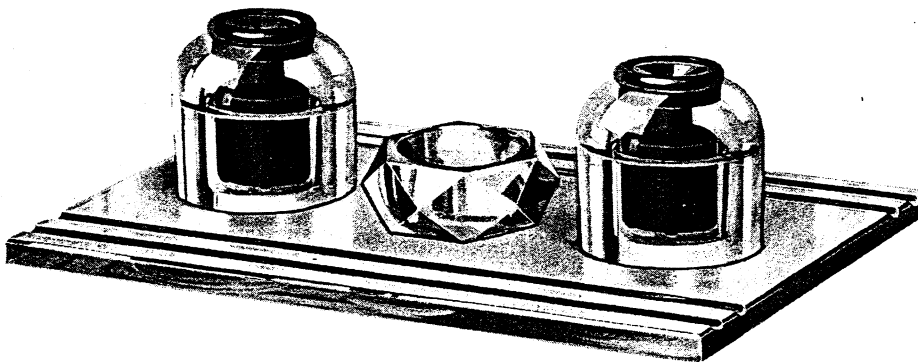

Above Illustrates No. 375, Double Desk, with No. 55

	Set Complete	Without Felt Mat	Base Only	Felt Mat for Base
No. 371—Double Desk Base, Size 7x 9 in., with one No. 51 or No. 55..	\$ 8.00	\$ 6.00		\$.70
No. 373— " " " " 8x11 in., " two No. 51 " No. 55..	13.50	9.50		.90
*No. 375— " " " " 9x13½ in., " two No. 51 " No. 55..	15.00	11.00		1.20

*Price includes Cut Glass Pin Cup.

For Executives' Offices, Bankers' Desks and Directors' Tables

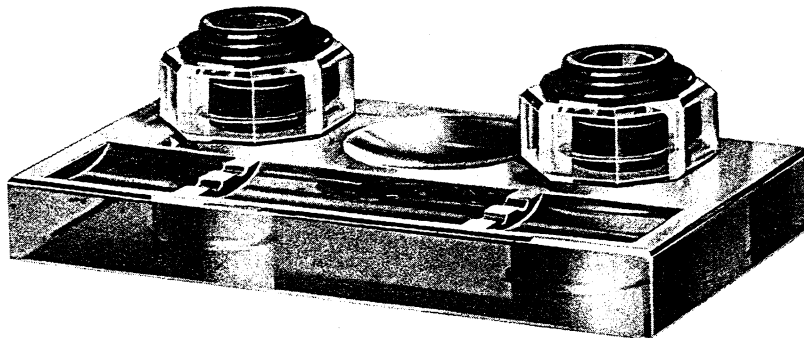

Above Illustrates No. 500

	Set Complete	Without Felt Mat	Base Only	Felt Mat for Base
No. 500—1½ in. thick Single Desk Base, Size 12 x 6½ in., with two No. 57.....	\$27.00	\$22.00		\$1.00
No. 501--1½ in. " Double " " " 13½x10 in., " two No. 57.....	32.00	27.00		1.40

Felt Mats with Pinked Edges may be had in Green, Brown and Maroon colors.

Black and Emeraldine Desk Sets

With Bronze Top Inkstands

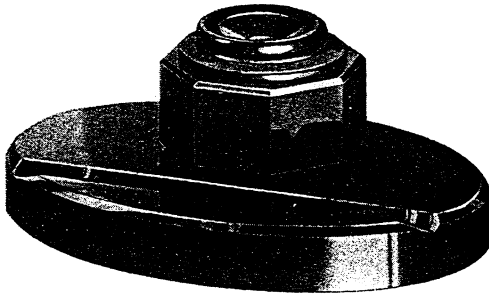

Above Illustrates No. 1931 Black

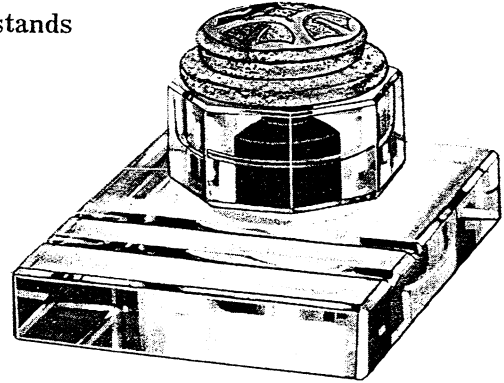

Above Illustrates No. 940 Emeraldine

No. 1930—Emeraldine, with No. 57 Crystal Glass Inkstand..... \$8.50
 No. 1931—Black, with No. 57 Black Glass Inkstand..... 9.00
 Size of Base 7x4½x1 in. Oval.

No. 940—Emeraldine, with No. 57-S Crystal Glass Inkstand.... \$14.00
 No. 941—Black, with No. 57-SS Black Glass Inkstand..... 14.50
 Size of Base 6x4¼x1 in.

Above Sets can be supplied with or without bronze tops, if so specified. Price of bronze tops, \$6.00 each.

Emeraldine Ash Trays with Brass Match Holder

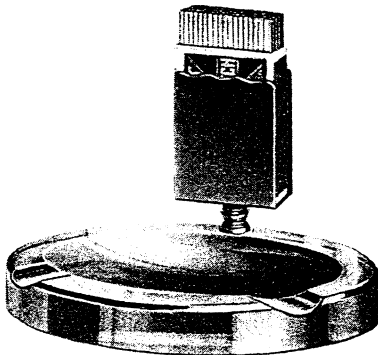

Made of ¾ In. Plate Glass

No. 565—Oval. Size 4x5½ in..... Complete \$5.00

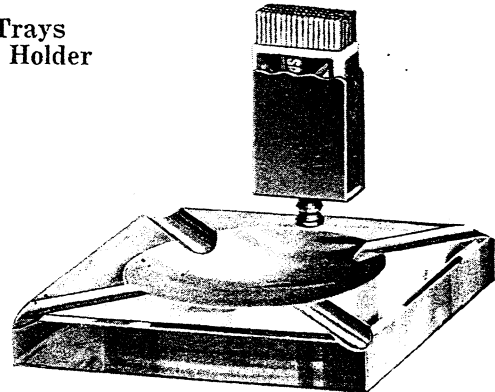

Made of 1 In. Plate Glass

No. 560—Square. Size 5x5 in..... Complete \$6.00

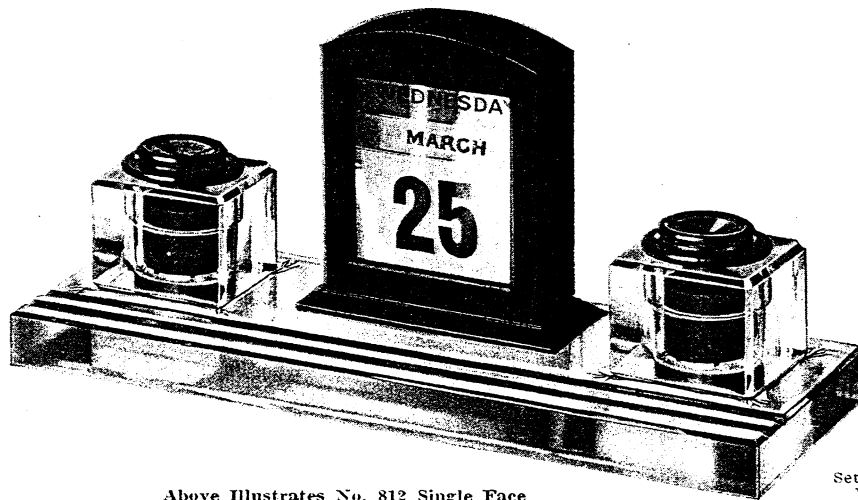

Above Illustrates No. 812 Single Face

No.	Face	with two No. 52 Inkstands and Oak Finish Daily Perpetual Calendar.	Set Complete Without Felt Mat	Felt Mat for Base
No. 810	Single	\$25.00	\$1.00
No. 811	Double	30.00	1.25
No. 812	Single	Mah.	26.00	1.00
No. 813	Double	31.00	1.25
No. 814	Single	Wal.	27.00	1.00
No. 815	Double	32.00	1.25

Size of Single Face Base 16x6 x1¼ in.—Height of Calendar 6¼ in.
 Size of Double Face Base 16x7½x1¼ in.—Height of Calendar 6¼ in.

Felt Mats with Pinked Edges may be had in Green, Brown and Maroon colors.

Jungbush

Colonial Base Sets - Oak Mahogany Walnut



With No. 52 Cut Glass Inkstand

All our Colonial Bases are made of select quarter-sawn oak, genuine mahogany, or genuine walnut, and are finished to match the prevailing colors of desks.

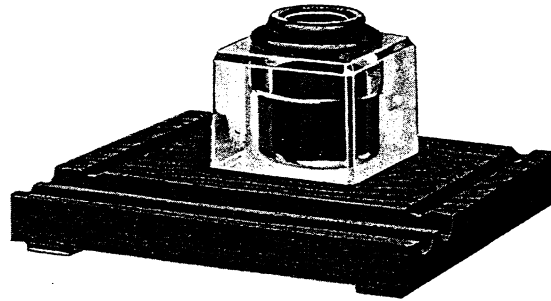

Above Illustrates No. 405 Walnut

Single Desk		Set Complete	Base Only	Double Desk		Set Complete	Base Only
No. 401—Oak Base with one No. 52		\$ 1.25	\$1.75	No. 403—Oak Base with one No. 52		\$ 4.50	\$2.00
No. 402—Mah. " " " No. 52		4.50	2.00	No. 404—Mah. " " " No. 52		5.00	2.50
No. 405—Wal. " " " No. 52		4.50	2.00	No. 406—Wal. " " " No. 52		5.00	2.50

Size of Base 6 3/4 x 7 3/4 x 1 3/8 in.

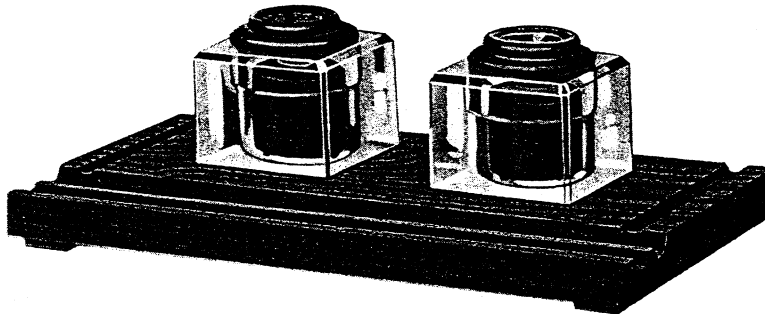

Above Illustrates No. 415 Walnut

Single Desk		Set Complete	Base Only	Double Desk		Set Complete	Base Only
No. 411—Oak Base with two No. 52		\$ 7.75	\$2.75	No. 413—Oak Base with two No. 52		\$ 8.25	\$3.25
No. 412—Mah. " " " No. 52		8.00	3.00	No. 414—Mah. " " " No. 52		8.75	3.75
No. 415—Wal. " " " No. 52		8.00	3.00	No. 416—Wal. " " " No. 52		8.75	3.75

Size of Base 6 3/4 x 13 1/4 x 1 3/8 in.

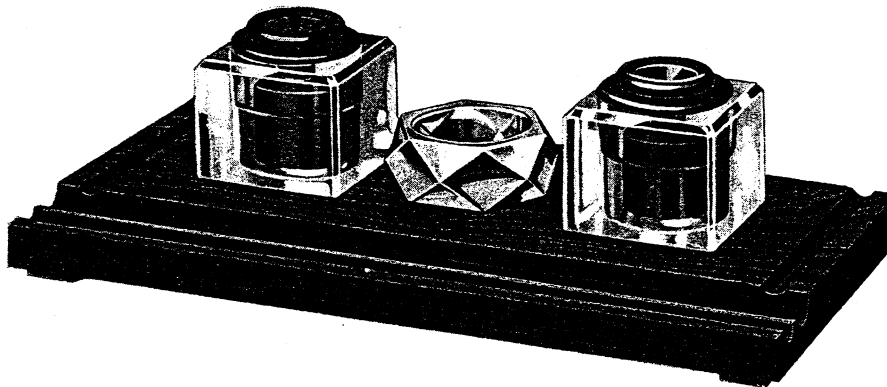

Above Illustrates No. 425 Walnut

Single Desk		Set Complete	Base Only	Double Desk		Set Complete	Base Only
*No. 421—Oak Base with two No. 52		\$ 8.75	3.75	*No. 423—Oak Base with two No. 52		\$ 9.50	\$4.50
*No. 422—Mah. " " " No. 52		9.00	4.00	*No. 424—Mah. " " " No. 52		10.00	5.00
*No. 425—Wal. " " " No. 52		9.00	4.00	*No. 426—Wal. " " " No. 52		10.00	5.00

Size of Base 7 3/4 x 15 x 1 3/8 in.

*Price includes Cut Glass Pin Cup.

NOTE—Wherever No. 52 is illustrated and listed with Bases, No. 53 plain glass Well may be substituted at 25 cents less for each Well.

Singmaster

Colonial Base Sets - Oak Mahogany Walnut

With No. 57 Cut Glass Inkstand

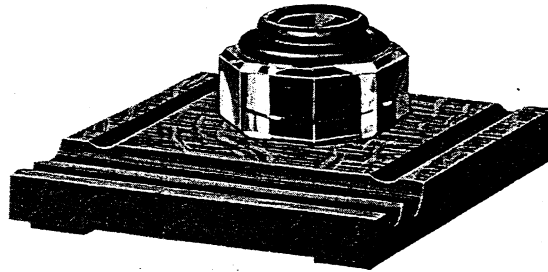

Above Illustrates No. 431 Oak

Single Desk		Set Complete	Base Only	Double Desk		Set Complete	Base Only
No. 431—Oak Base with one No. 57.....		\$ 4.25	\$1.75	No. 433—Oak Base with one No. 57.....		\$ 4.50	\$2.00
No. 432—Mah. " " " No. 57.....		4.50	2.00	No. 434—Mah. " " " No. 57.....		5.00	2.50
No. 435—Wal. " " " No. 57.....		4.50	2.00	No. 436—Wal. " " " No. 57.....		5.00	2.50
Size of Base 6¼x6¼x1½ in.				Size of Base 8¼x6¼x1½ in.			

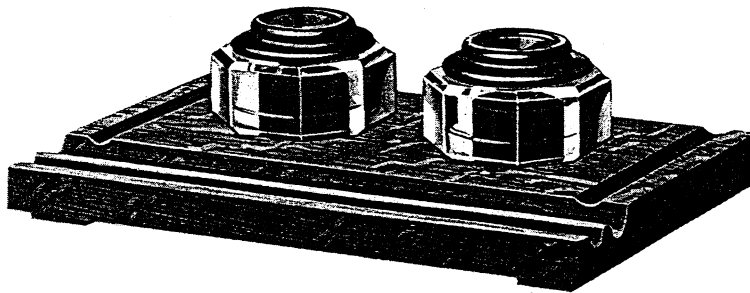

Above Illustrates No. 441 Oak

Single Desk		Set Complete	Base Only	Double Desk		Set Complete	Base Only
No. 441—Oak Base with two No. 57.....		\$ 7.75	\$2.75	No. 443—Oak Base with two No. 57.....		\$ 8.25	\$3.25
No. 442—Mah. " " " No. 57.....		8.00	3.00	No. 444—Mah. " " " No. 57.....		8.75	3.75
No. 445—Wal. " " " No. 57.....		8.00	3.00	No. 446—Wal. " " " No. 57.....		8.75	3.75
Size of Base 6¼x11x1½ in.				Size of Base 8¼x11x1½ in.			

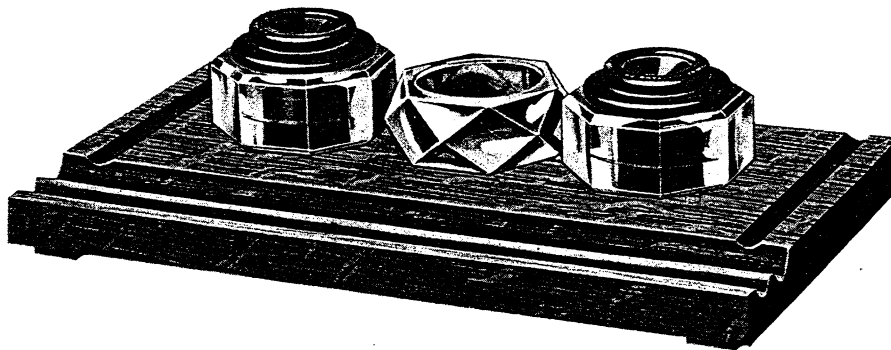

Above Illustrates No. 451 Oak

Single Desk		Set Complete	Base Only	Double Desk		Set Complete	Base Only
*No. 451—Oak Base with two No. 57.....		\$ 8.75	\$3.75	*No. 453—Oak Base with two No. 57.....		\$ 9.50	\$4.50
*No. 452—Mah. " " " No. 57.....		9.00	4.00	*No. 454—Mah. " " " No. 57.....		10.00	5.00
*No. 455—Wal. " " " No. 57.....		9.00	4.00	*No. 456—Wal. " " " No. 57.....		10.00	5.00
Size of Base 7¼x13½x1½ in.				Size of Base 9¼x13½x1½ in.			

*Price includes Cut Glass Pin Cup.

NOTE—Wherever No. 57 is illustrated and listed with Bases, No. 56 or No. 60 Plain Glass Well may be substituted at 50 cents less for each Well.

Standard Base Sets-Oak and Mahogany

Wood Bases for No. 51, No. 55 and No. 56 "Sengbusch" Inkstands

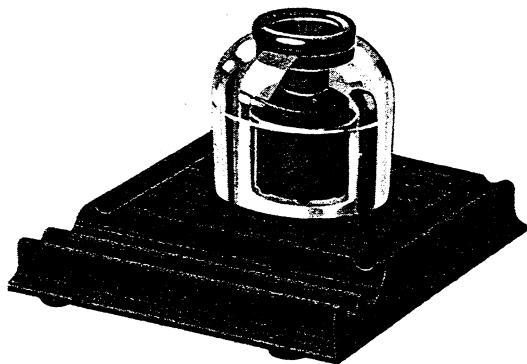

Above Illustrates No. 106 Mahogany with No. 55 Inkstand

	Single Desk	Set Complete	Base Only
No. 105—Oak Base with one No. 51 or No. 55...		\$ 3.75	\$1.75
No. 106—Mah. " " " No. 51 " No. 55...		4.00	2.00
	Size of Base 6¼x6¼x1¾ in.		
No. 131—Oak Base with one No. 56.....		\$ 3.75	\$1.75
No. 132—Mah. " " " No. 56.....		4.00	2.00
	Size of Base 5¾x6x1¾ in.		

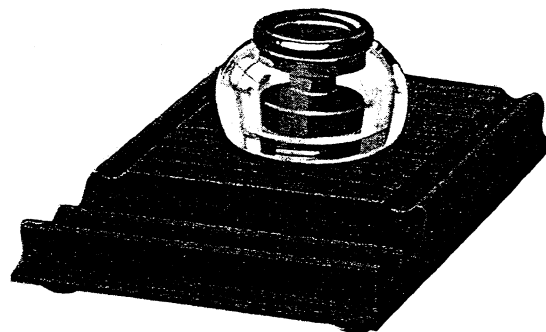

Above Illustrates No. 132 Mahogany with No. 56 Inkstand

	Double Desk	Set Complete	Base Only
No. 107—Oak Base with one No. 51 or No. 55...		\$ 4.00	\$2.00
No. 108—Mah. " " " No. 51 " No. 55...		4.50	2.50
	Size of Base 8¼x6¼x1¾ in.		
No. 133—Oak Base with one No. 56.....		\$ 4.00	\$2.00
No. 134—Mah. " " " No. 56.....		4.50	2.50
	Size of Base 7½x6x1¾ in.		

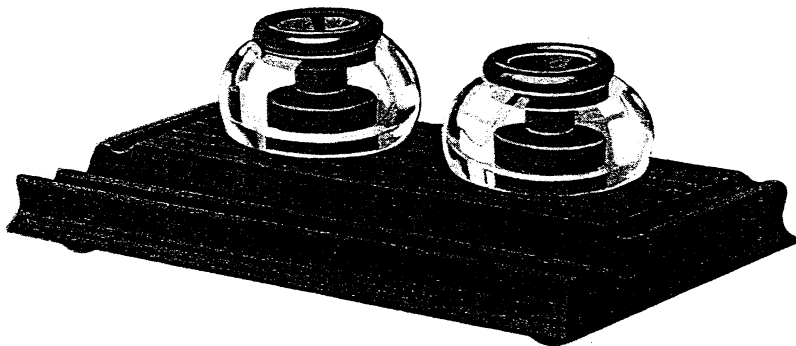

Above Illustrates No. 142 Mahogany with No. 56 Inkstand

	Single Desk	Set Complete	Base Only	Double Desk	Set Complete	Base Only
No. 141—Oak Base with two No. 56.....		\$ 6.75	\$2.75	No. 143—Oak Base with two No. 56.....	\$ 7.25	\$3.25
No. 142—Mah. " " " No. 56.....		7.00	3.00	No. 144—Mah. " " " No. 56.....	7.75	3.75
	Size of Base 5¾x10x1¾ in.				Size of Base 7½x10x1¾ in.	
No. 115—Oak Base with two No. 51 or No. 55...		\$ 6.75	\$2.75	No. 117—Oak Base with two No. 51 or No. 55...	\$ 7.25	\$3.25
No. 116—Mah. " " " No. 51 " No. 55...		7.00	3.00	No. 118—Mah. " " " No. 51 " No. 55...	7.75	3.75
	Size of Base 6¼x11x1¾ in.				Size of Base 8¼x11x1¾ in.	

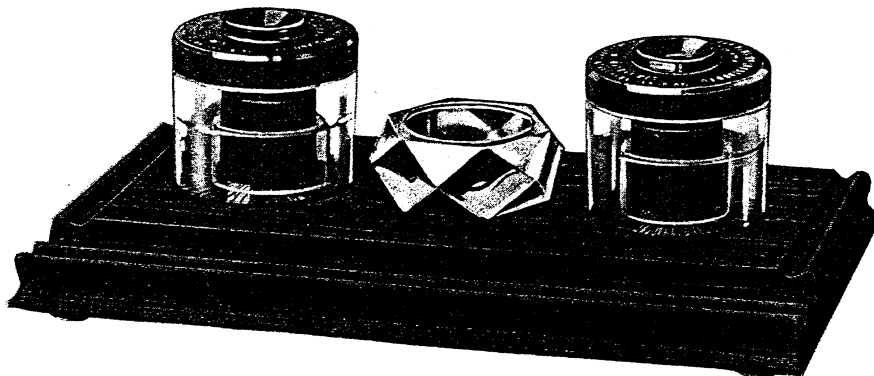

Above Illustrates No. 126 Mahogany with No. 51 Inkstand

	Single Desk	Set Complete	Base Only	Double Desk	Set Complete	Base Only
*No. 125—Oak Base with two No. 51 or No. 55...		\$ 7.50	\$3.50	*No. 127—Oak Base with two No. 51 or No. 55...	\$ 8.25	\$4.25
*No. 126—Mah. " " " No. 51 " No. 55...		7.75	3.75	*No. 128—Mah. " " " No. 51 " No. 55...	8.75	4.75
	Size of Base 7½x13¼x1¾ in.				Size of Base 9¼x13¼x1¾ in.	
*No. 151—Oak Base with two No. 56.....		\$ 7.50	\$3.50	*No. 153—Oak Base with two No. 56.....	\$ 8.25	\$4.25
*No. 152—Mah. " " " No. 56.....		7.75	3.75	*No. 154—Mah. " " " No. 56.....	8.75	4.75
	Size of Base 6½x12x1¾ in.				Size of Base 8½x12x1¾ in.	

*Price includes Pressed Glass Pin Cup.

When ordering Sets specify whether No. 51 or No. 55 Inkstand is wanted.

Bases Nos. 131 to 154, inclusive, may also be had with receptacles suitable for No. 62 Inkstand.

English

Super-Colonial Base Sets



Mahogany and Walnut Base Sets, with No. 52M Cut Glass Inkstand and No. 26 Adjustable Pen Socket

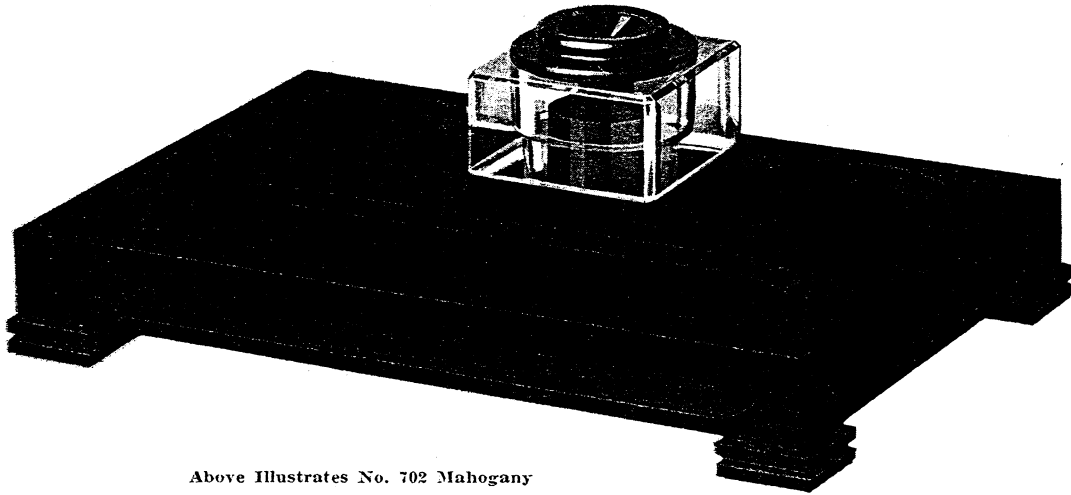

Above Illustrates No. 702 Mahogany

No. 702—Mah. Base for Single Desk with one No. 52M.....	Set Complete	\$17.50	Base Only	\$15.00
No. 705—Wal. " " " " " " No. 52M.....		17.50		15.00
Size of Base 8x12x1 1/4 in.				

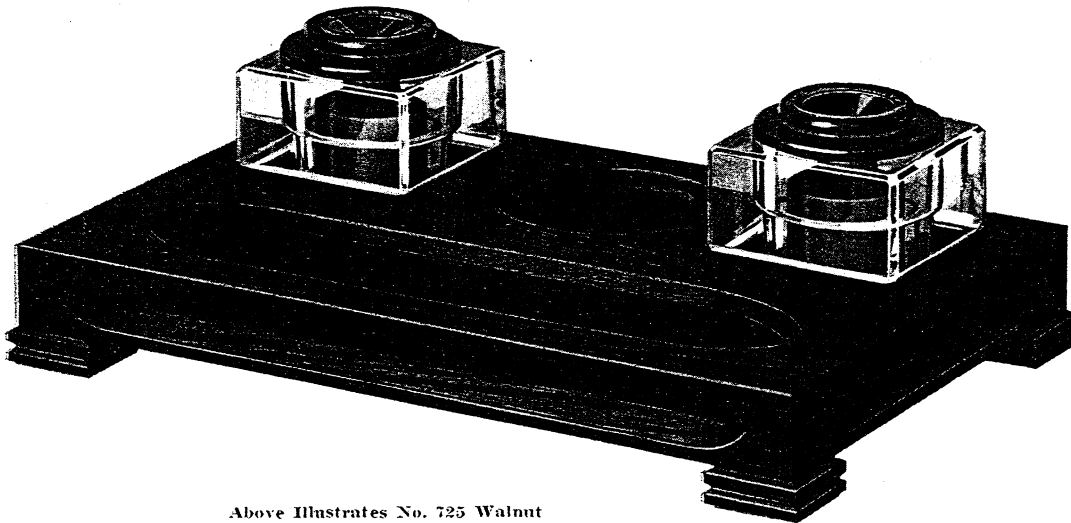

Above Illustrates No. 725 Walnut

No. 722—Mah. Base for Single Desk with two No. 52M.....	Set Complete	\$20.00	Base Only	\$15.00
No. 725—Wal. " " " " " " No. 52M.....		20.00		15.00
No. 1722—Mah. Base with one No. 52M Inkstand and one No. 26 Adjustable Pen Socket		22.50		15.00
No. 1725—Wal. " " " " No. 52M " " " " No. 26 " " " "		22.50		15.00
Size of Base 8x12x1 1/4 in.				

These High-class Bases are made in One Piece, Solid Mahogany and Solid Walnut. Rich and Massive in appearance, and in keeping with the Highest Grade Office Furniture.

W. J. ...

Pressed Glass Base Sets



With No. 56 Inkstand

A Highly Attractive Base at a Moderate Price.

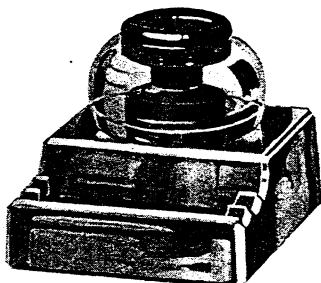

Above Illustrates No. 300

	Set Complete Without Felt Mat	Base Only	Felt Mat for Base
No. 300—Single Desk Base, Size 5 x4x1 1/4 in., with one No. 56.....	\$2.75	\$.75	\$.35
No. 301—Double " " " 6 1/4 x4x1 1/4 " " " No. 56.....	3.00	1.00	.40

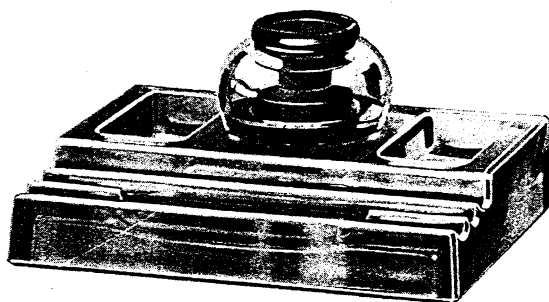

Above Illustrates No. 310

	Set Complete Without Felt Mat	Base Only	Felt Mat for Base
No. 310—Single Desk Base, Size 5 1/4 x7 1/4 x1 1/4 in., with one No. 56.....	\$3.25	\$1.25	\$.55
No. 311—Double " " " 7 1/4 x7 1/4 x1 1/4 " " " No. 56.....	3.75	1.75	.70

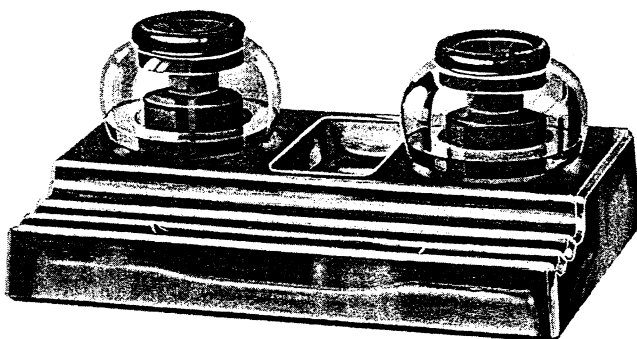

Above Illustrates No. 320

	Set Complete Without Felt Mat	Base Only	Felt Mat for Base
No. 320—Single Desk Base, Size 5 1/4 x8 1/4 x1 1/4 in., with two No. 56.....	\$5.25	\$1.25	\$.65
No. 321—Double " " " 7 1/4 x8 1/4 x1 1/4 " " " No. 56.....	5.75	1.75	.75

NOTE—Wherever No. 56 is illustrated and listed with Bases, No. 60 may be substituted without extra cost; and No. 57 may be substituted at 50 cents additional for each Well.

Felt Mats with Pinked Edges may be had in Green, Brown and Maroon colors.

White Cut and Pressed Glass Bases

For 3-inch and 3½-inch Square Inkstands (Nos. 52, 53 and 54) and 3-inch Round Inkstands (Nos. 51 and 55).

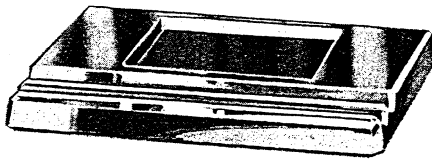

Above Illustrates Nos. 230 and 232

Cut Glass Bases with One Square Hole

No.	Description	Base Only	Felt Mat for Base
No. 230	for Single Desk with one 3 in. Sq. Hole...	\$3.25	\$.50
No. 230a	" " " " 3½ in. " " ...	3.25	.50
No. 231	" Double " " " 3 in. " " ...	4.00	.55
No. 231a	" " " " 3½ in. " " ...	4.00	.55

Cut Glass Bases with One Round Hole

No.	Description	Base Only	Felt Mat for Base
No. 234	for Single Desk with one 3 in. Rd. Hole...	\$3.25	\$.50
No. 235	" Double " " " 3 in. " " ...	4.00	.55

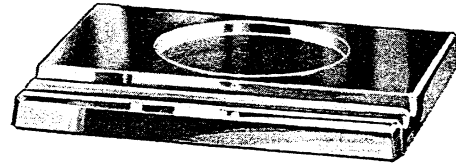

Above Illustrates Nos. 234 and 236

Pressed Glass Bases with One Square Hole

No.	Description	Base Only	Felt Mat for Base
No. 232	for Single Desk with one 3 in. Sq. Hole...	\$1.25	\$.50
No. 232a	" " " " 3½ in. " " ...	1.25	.50
No. 233	" Double " " " 3 in. " " ...	1.75	.55
No. 233a	" " " " 3½ in. " " ...	1.75	.55

Pressed Glass Bases with One Round Hole

No.	Description	Base Only	Felt Mat for Base
No. 236	for Single Desk with one 3 in. Rd. Hole...	\$1.25	\$.50
No. 237	" Double " " " 3 in. " " ...	1.75	.55

Size of all the above Single Desk Bases 6¼x6¼x¾ in.
Size of all the above Double Desk Bases 7x6¼x¾ in.

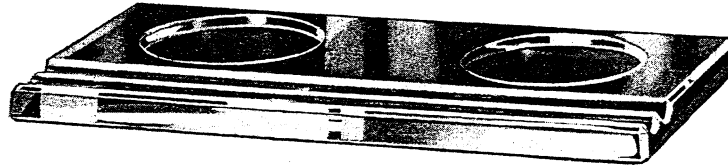

Above Illustrates Nos. 244 and 246

Cut Glass Bases with Two Square Holes

No.	Description	Base Only	Felt Mat for Base
No. 240	for Single Desk with two 3 in. Sq. Holes...	\$5.25	\$.75
No. 240a	" " " " 3½ in. " " ...	5.25	.75
No. 241	" Double " " " 3 in. " " ...	6.25	.85
No. 241a	" " " " 3½ in. " " ...	6.25	.85

Cut Glass Bases with Two Round Holes

No.	Description	Base Only	Felt Mat for Base
No. 244	for Single Desk with two 3 in. Rd. Holes...	\$5.25	\$.75
No. 245	" Double " " " 3 in. " " ...	6.25	.85

Pressed Glass Bases with Two Square Holes

No.	Description	Base Only	Felt Mat for Base
No. 242	for Single Desk with two 3 in. Sq. Holes...	\$2.25	\$.75
No. 242a	" " " " 3½ in. " " ...	2.25	.75
No. 243	" Double " " " 3 in. " " ...	2.75	.85
No. 243a	" " " " 3½ in. " " ...	2.75	.85

Pressed Glass Bases with Two Round Holes

No.	Description	Base Only	Felt Mat for Base
No. 246	for Single Desk with two 3 in. Rd. Holes...	\$2.25	\$.75
No. 247	" Double " " " 3 in. " " ...	2.75	.85

Size of all the above Single Desk Bases 6x11x¾ in.
Size of all the above Double Desk Bases 7x11x¾ in.

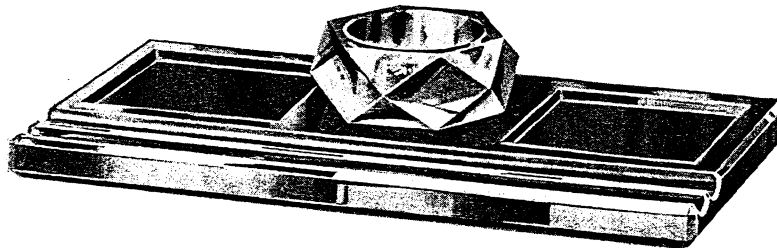

Above Illustrates Nos. 250 and 252

Cut Glass—Two Square Holes and Pin Cup

No.	Description	Base Only	Felt Mat for Base
No. 250	for Single Desk with two 3 in. Sq. Holes...	\$6.00	\$.75
No. 250a	" " " " 3½ in. " " ...	6.00	.75
No. 251	" Double " " " 3 in. " " ...	7.50	.85
No. 251a	" " " " 3½ in. " " ...	7.50	.85

Cut Glass—Two Round Holes and Pin Cup

No.	Description	Base Only	Felt Mat for Base
No. 254	for Single Desk with two 3 in. Rd. Holes...	\$6.00	\$.75
No. 255	" Double " " " 3 in. " " ...	7.50	.85

Pressed Glass—Two Square Holes and Pin Cup

No.	Description	Base Only	Felt Mat for Base
No. 252	for Single Desk with two 3 in. Sq. Holes...	\$2.50	\$.75
No. 252a	" " " " 3½ in. " " ...	2.50	.75
No. 253	" Double " " " 3 in. " " ...	3.00	.85
No. 253a	" " " " 3½ in. " " ...	3.00	.85

Pressed Glass—Two Round Holes and Pin Cup

No.	Description	Base Only	Felt Mat for Base
No. 256	for Single Desk with two 3 in. Rd. Holes...	\$2.50	\$.75
No. 257	" Double " " " 3 in. " " ...	3.00	.85

Base Price includes Pin Cup

Cut Glass Pin Cup, 75c each.

Pressed Glass Pin Cup, 25c each.

Size of all the above Single Desk Bases 6x11x¾ in.
Size of all the above Double Desk Bases 7x11x¾ in.

Felt Mats with Pinked Edges may be had in Green, Brown and Maroon colors for all Bases on this page.

Ideal Sanitary Moistener

Clean—Economical—Sanitary—Efficient

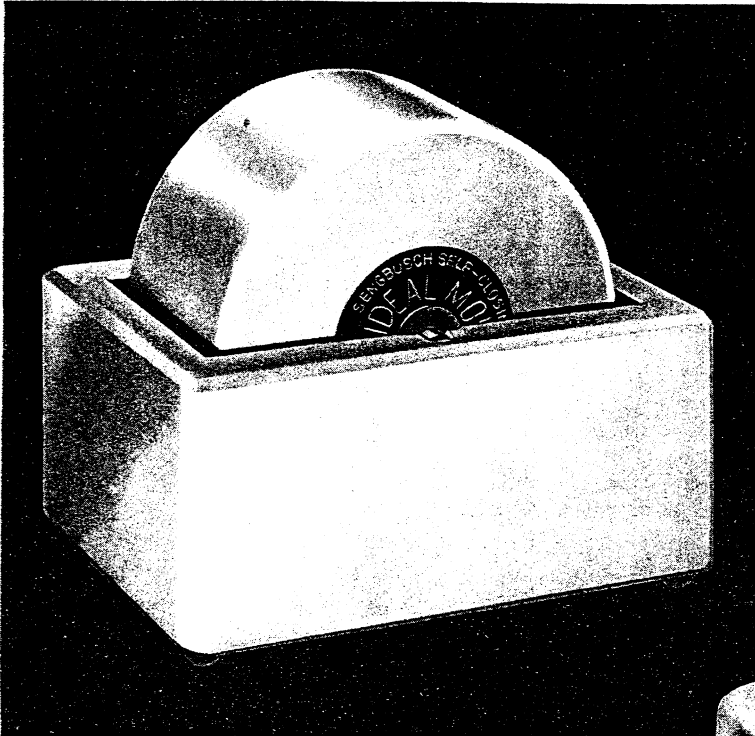

Ideal Sanitary Moistener (shown at left)

Price Complete, \$1.50 Each

Size of Base $3\frac{1}{4} \times 4\frac{1}{4}$ in.
Size of Roller 3 in. Diam. x 2 in. Wide

Base only	\$.50
Roller only50
Metal parts only50

Ideal Junior Moistener (shown at right)

Price Complete, 50 Cents Each

Size of Base $2\frac{1}{4} \times 2\frac{1}{2}$ in.
Size of Roller $1\frac{1}{2}$ in. Diam. x $1\frac{1}{8}$ in. Wide

Base only	\$.25
Roller only25

Notice

Ideal Junior Moisteners are packed in individual containers, one dozen to a carton.

Only orders of one dozen or more will be accepted.

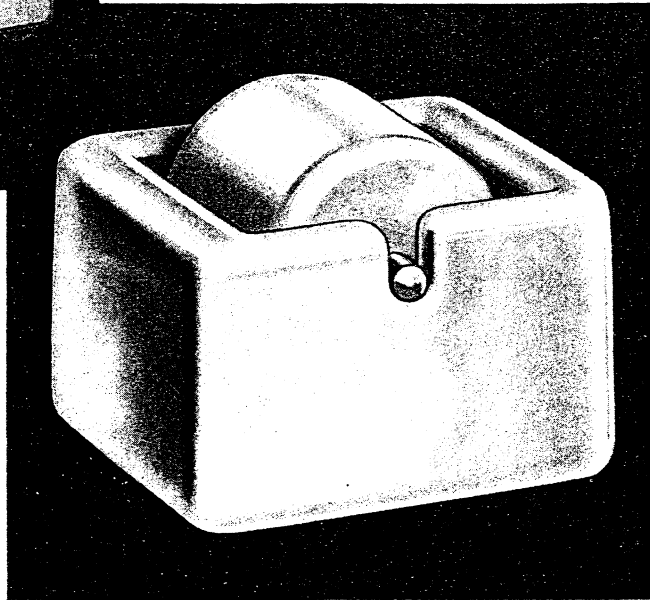

Do It "The Quick and Easy Way" with an Ideal

Ideal Moisteners are the sanitary way to moisten fingers, envelopes, stamps, labels, etc., applying the right amount of moisture, quickly, surely and easily. The wheel revolves without resistance or noise. Made of glazed white porcelain, with nickel plated metal parts. Nothing to wear out, no added expense.

The Ideal Junior Moistener is especially adapted for finger and general light duty office use.

No-Over-Flo Sponge Cup

Handy—Neat—Firm—Solid

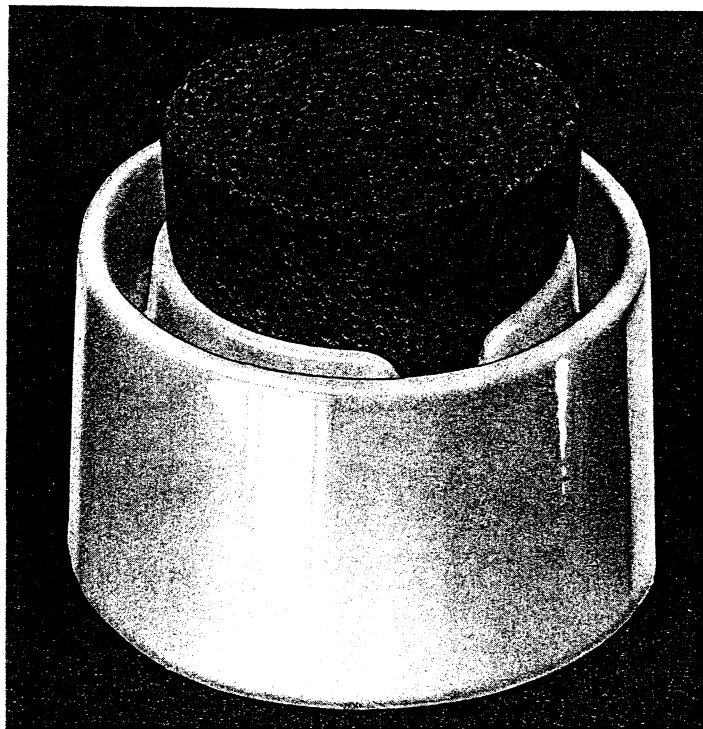

	With Sponge	Cup Only
No. 5—White Porcelain.....	\$1.00 each	\$.75 each
No. 6—Green Porcelain.....	1.25 each	1.00 each
No. 7—Brown Porcelain.....	1.25 each	1.00 each
	Red Rubber Sponges 25 cents each.	
	Size 4¼ in. diameter x 2½ in. high.	

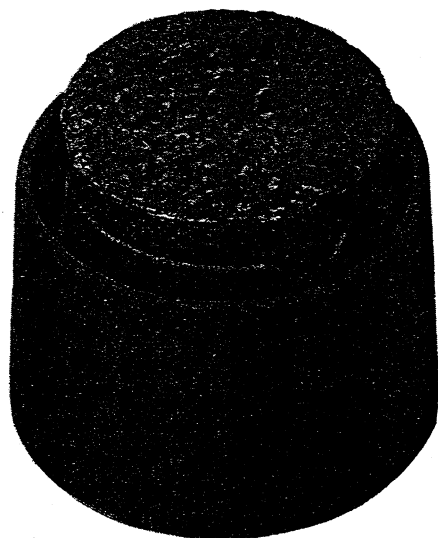

No. 10—Maroon Composition... \$.75 ea. \$.55 ea.
Red Rubber Sponges 20 cents each.
Size 3¼ in. diameter x 2¼ in. high.



No. 11—Green Composition... \$.75 ea. \$.55 ea.
Red Rubber Sponges 20 cents each.
Size 3¼ in. diameter x 2¼ in. high.

Just What the Name Implies!

No splashing over furniture or papers when sponge is pressed—inner chamber takes care of over-flow. Liquid flows back into sponge when pressure is released.

The No-Over-Flo is not easily upset nor pushed out of place when in use. Its broad base and substantial weight keep it firm and steady. The Sengbusch close-fitting sponge stays firmly in place with just enough projecting to make it handy to use. Made of live red rubber of exceptional fineness of texture, it retains moisture and reduces evaporation to a minimum. If preferred, a natural sponge of the proper size may be used with satisfaction.

Kleradesk



Equals Six Baskets or Trays—Occupies Less Desk Space Than One

Made of interchangeable, vertical steel sections. Extra sections can be added as needed or complete models can be purchased with any number of compartments.

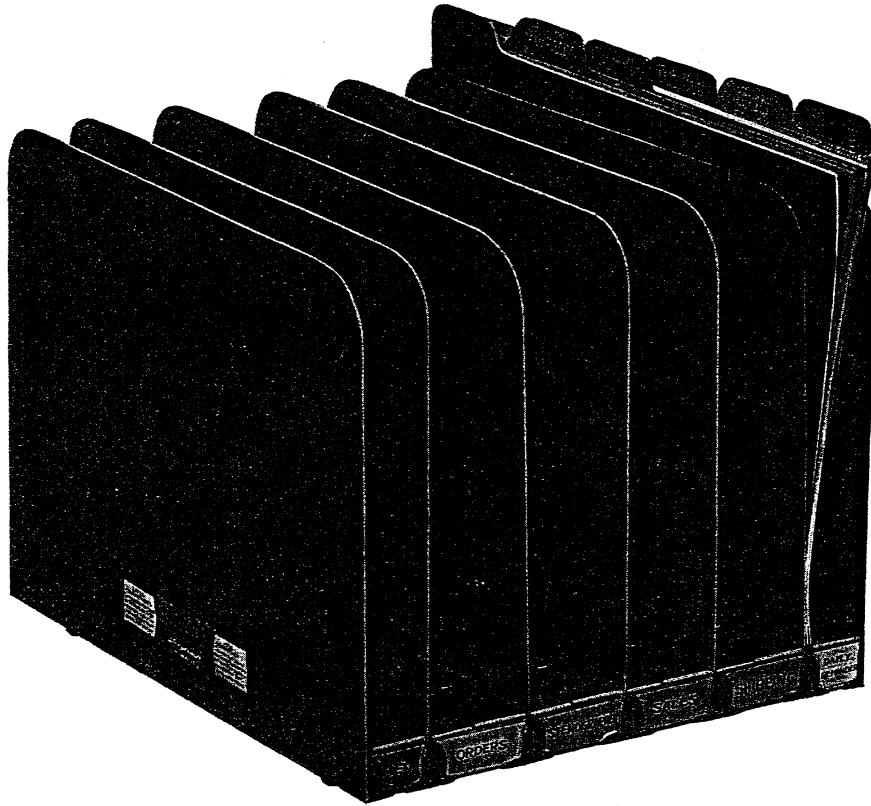

Above illustrates Model 6V in Green, with "Daily Reminder" Folders. Requires less space than wire basket or wooden tray.

It is a six-compartment equipment and is made up with two end and five center sections. It is an extremely popular model, its six compartments being adaptable to the needs of practically every business man's desk. The "Daily Reminder" Colored Signal Folders, shown in the above Model, are an exceptionally valuable feature. One merely lifts out each day's folder and it calls to one's attention the papers and work that should be attended to during the day.

Eight Interchangeable Steel Sections

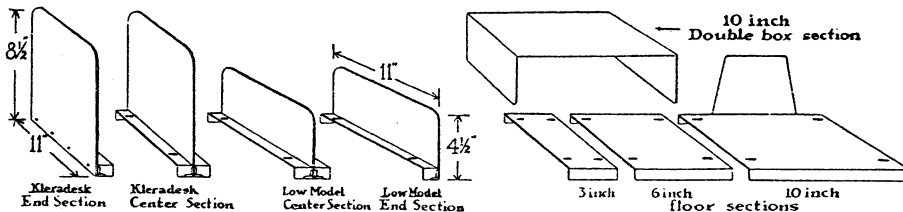

Above is a diagram illustration of the eight standard Kleradesk sections from which any kind of a Kleradesk model may be assembled. All sections are made of sheet steel and fastened together by a "combination bolt and bumper-foot"—no tools required. High and low sections can be used together when desired. Floor flanges, on end and center sections, make compartments adjustable from 1 inch to 1 3/4 inches between uprights. The 3-inch, 6-inch and 10-inch floor sections are not required for regular Kleradesk equipment, but are provided to meet the demand for extra wide compartments. The 10-inch floor section is for flat filing and has a back piece that prevents papers from falling out. When two 10-inch spaces are desired, the 10-inch Double Box Section should be ordered with a single 10-inch floor section. All compartments can be indexed front and back.

Finished in Oak, Mahogany, Walnut and Olive Green

Kleradesk

Prevents Confusion and Gives You Greater Desk Efficiency

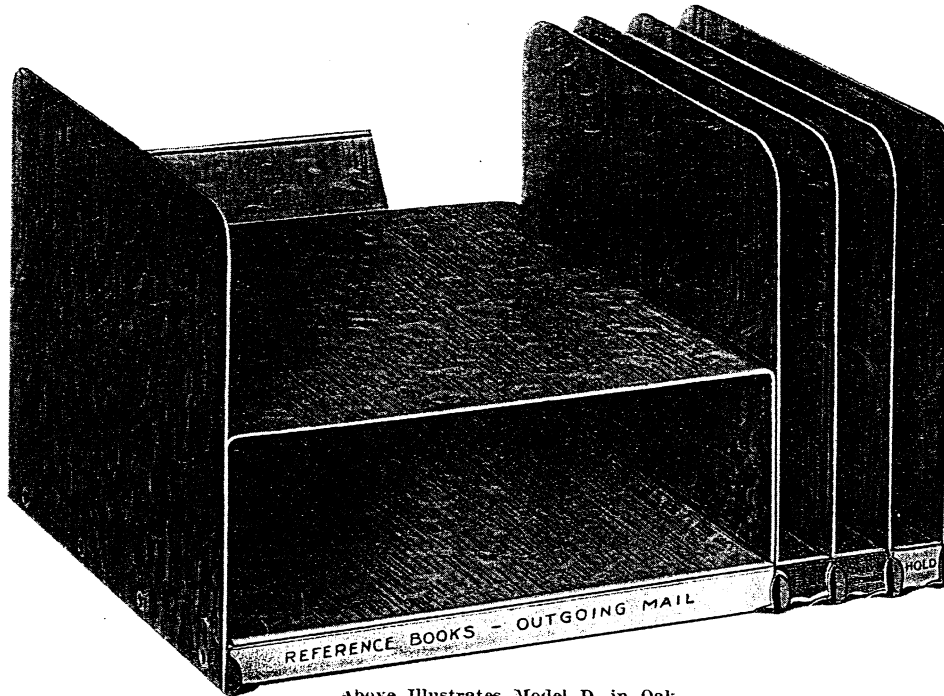

Above Illustrates Model D. in Oak.

Kleradesk will help every Executive, Clerk and Stenographer to better organize their desk work along the following lines:

1. More convenient temporary holding of matters that cannot be disposed of at once.
2. Quicker and automatic dispatching of papers to be distributed to others.
3. Greater convenience in holding permanent reference matters for instant availability.

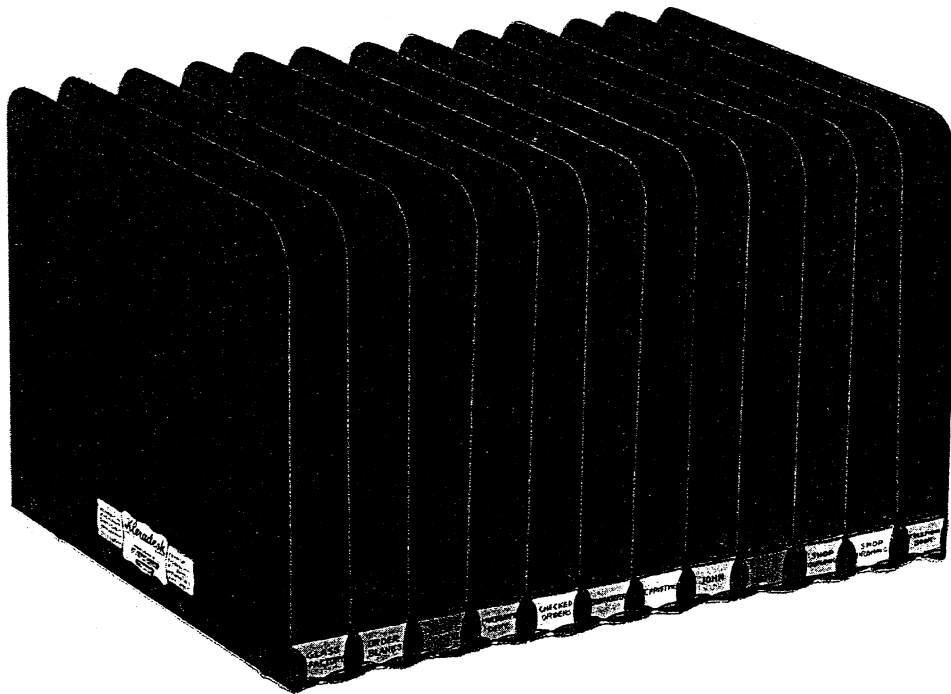

Above Illustrates Model 12V, in Mahogany

The Most Flexible Desk Distributor Ever Invented

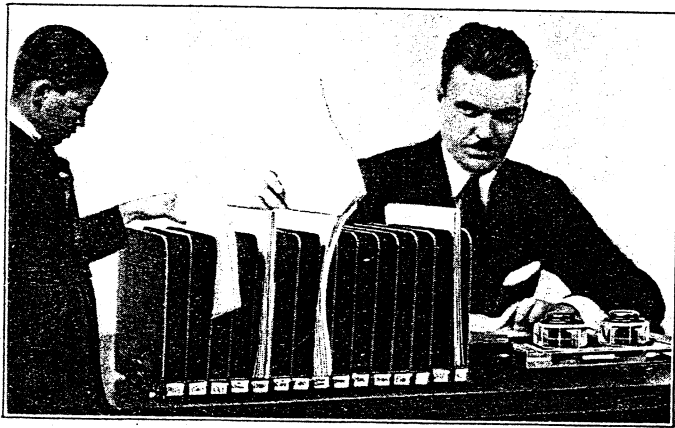

Placing papers in labeled compartments, automatically routes and instructs messenger where to deliver.

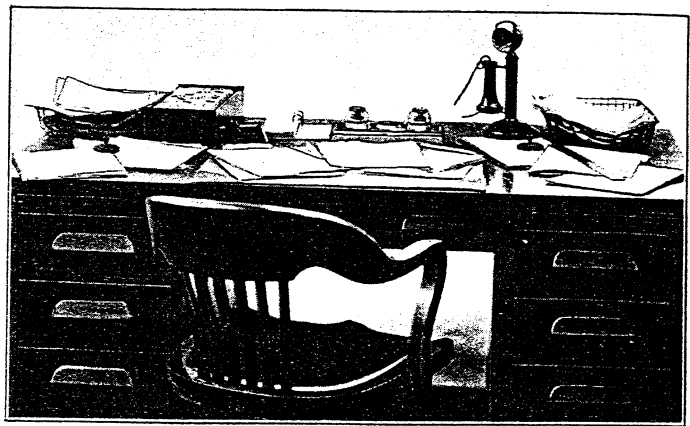

Every paper on this desk is in Kleradesk on opposite desk.



Low model for checks, currency, memos, etc.

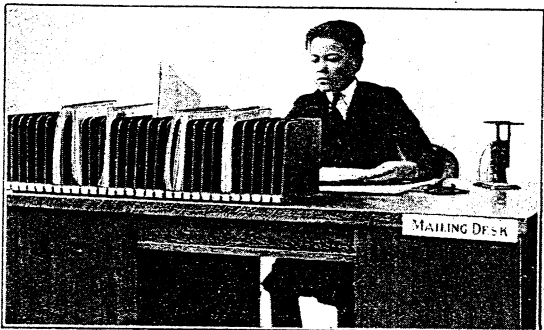

30 compartments use less space than 3 baskets.



Use Kleradesk for preliminary sorting — one compartment for each drawer — will save 20 per cent of filing time.

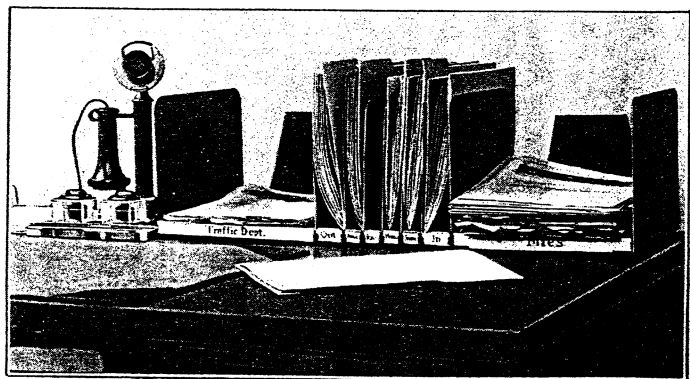

Combining both flat and vertical handling of letters, it fits into your present desk system.

Finished in Oak, Mahogany, Walnut and Olive Green

Price List for Sections

	Oak	Mahogany	Walnut	Green
High End or Center Sections (8½"x11")	\$1.10			\$.90
Low End or Center Sections (4½"x11")	1.10			.90
Double Box Sections (10")	1.10			.90
3-in. Floor Sections	.75			.60
6-in. " "	.90			.75
10-in. " "	1.10			.90
Colored "Daily Reminder" Signal Folders, per set of six				\$.50

Low Model Kleradesk

For Checks, Currency and General Sorting

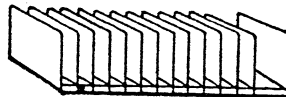

Model F for vertical sorting.
Green\$13.20
Walnut, Oak or Mahogany.... 16.15

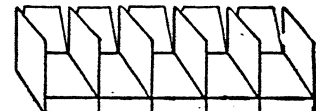

Model 5-H for flat sorting.
Green\$ 8.40
Walnut, Oak or Mahogany.... 10.35

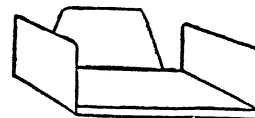

Model E Steel Desk Tray. Green..\$2.70
Walnut, Oak or Mahogany..... 3.30

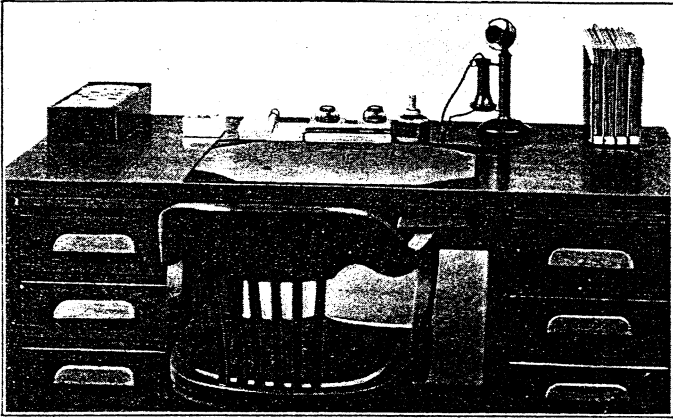

This small Kleradesk contains every paper on opposite desk.



Small stenographers' desks, made roomy, develop efficiency.

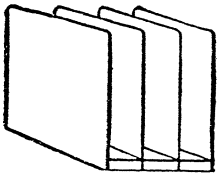

Model 3-V. Green\$3.60
Walnut Oak or Mahogany... 4.40

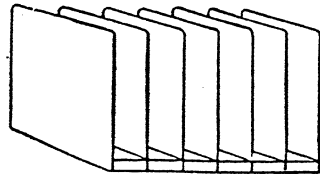

Model 6-V. Green.....\$6.30
Walnut, Oak or Mahogany.. 7.70

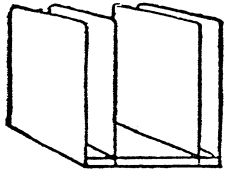

Model C. Green.....\$4.20
Walnut, Oak or Mahogany.. 5.15

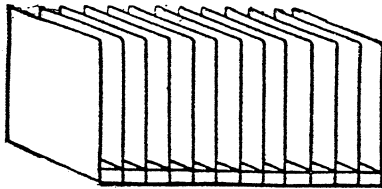

Model 12-V. Green.....\$11.70
Walnut, Oak or Mahogany. 14.30

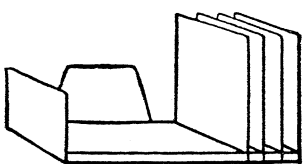

Model A. Green.....\$5.40
Walnut, Oak or Mahogany.. 6.60

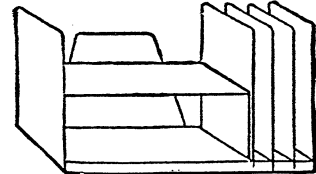

Model D. Green.....\$6.30
Walnut, Oak or Mahogany... 7.70

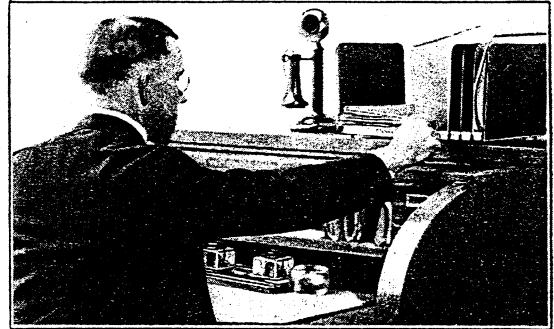

Easy to use on every type of desk.

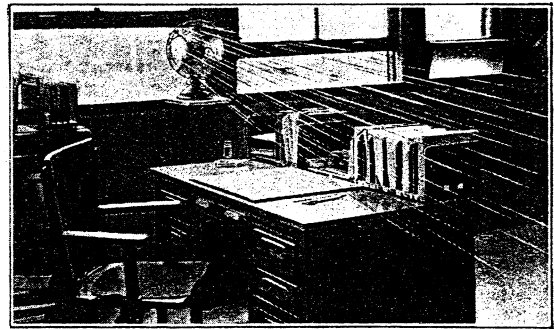

Papers filed vertically in Kleradesk will not be blown away.

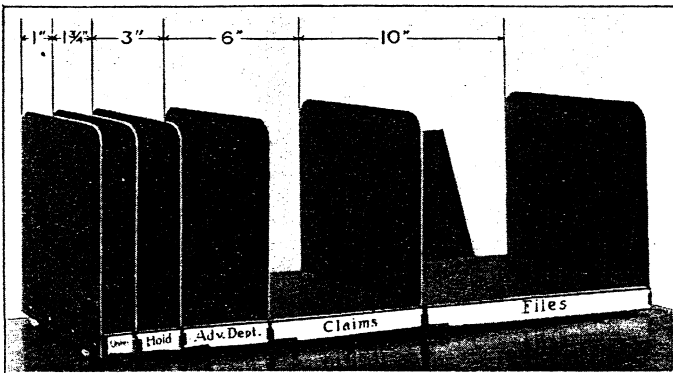

Compartments of any width.

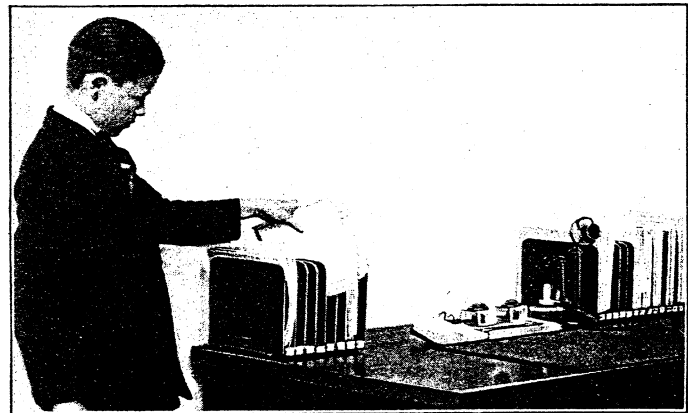

One for distributing — one for holding papers.

Sengbusch

INDEX



	Page		Page
Adjustable Pen Sockets.....	8	Kleradesk, Price List for Single Sections.....	30
Ash Trays, Emeraline Plate Glass.....	19	Kleradesk, Complete Models.....	30 and 31
Black Glass Bases with No. 57 Inkstand.....	19	Mahogany Bases with Nos. 52 and 53 Inkstands.....	20
Bronze Top Inkstands.....	19	Mahogany Bases with No. 57 Inkstand.....	21
Calendar Sets, Oak, Mahogany and Walnut.....	19	Mahogany Bases with Nos. 51, 56 and 62 Inkstands.....	22
Calendars, Gold Plated.....	7	Marble Bases with No. 57 Inkstand.....	15
Daily Reminder Folders, Kleradesk.....	30	No-Mar Rubber Bases with Nos. 51 and 55 Inkstands.....	11
Dipaday Desk Sets with No. 73 Inkstand.....	4, 5, 6, and 7	No-Mar Rubber Bases with No. 52 Inkstands.....	12
Dipaday Desk Sets with No. 70 Inkstand.....	8	No-Mar Rubber Bases with Nos. 56, 57 and 60 Inkstands.....	13
Dipaday Pens in colors, Nos. 43 and 63.....	2	No-Over-Flo Sponge Cups (Porcelain).....	27
Dipaday Pens, Nos. 40 and 60.....	3	No-Over-Flo Sponge Cups (Composition).....	27
Dipaday Pen Repair Parts.....	3	Oak Bases with Nos. 52 and 53 Inkstands.....	20
Dipaday Nibs, Nos. 4 and 6.....	3	Oak Bases with No. 57 Inkstands.....	21
Emeraline Bases, with No. 52 Inkstand.....	14	Oak Bases with Nos. 51, 55, 56 and 62 Inkstands.....	22
Emeraline Bases, with No. 57 Inkstand.....	15	Onyx Bases with No. 57 Inkstand.....	15
Emeraline Bases (Oval), with No. 57 Inkstand.....	16	Ornaments for Dipaday Desk Sets.....	5, 6, and 7
Emeraline Bases (4½ in. wide), with Nos. 52 and 57 Inkstands.....	17	Pressed Glass Bases for Nos. 56, 57 and 60 Inkstands.....	24
Emeraline Bases (½ in. thick), with Nos. 51 and 55 Inkstands.....	18	Pressed Glass Bases for Nos. 51, 52, 53 and 55 Inkstands.....	25
Emeraline Bases (1½ in. thick), with No. 57 Inkstand.....	18	Rubber Inkstands, Nos. 70 to 76 inclusive.....	10
Felt Mats for all Glass Bases.....	14-19, 24 and 25	Super-Colonial Base Sets, Mahogany and Walnut.....	23
Glass Inkstands, Nos. 51 to 64 inclusive.....	9	School Inkstand, No. 71.....	10
Hotel Inkstands.....	9 and 10	Sponges for No-Over-Flo Sponge Cups.....	27
Ideal Moistener.....	26	Trophies, Sport and Athletic.....	6
Ideal Junior Moistener.....	26	Walnut Bases with Nos. 52 and 53 Inkstands.....	20
Inkstands, Single.....	9 and 10	Walnut Bases with No. 57 Inkstands.....	21
Inkstands, Price List for Parts.....	10	White Cut Glass Bases for Nos. 51, 52, 53, 54 and 55 Inkstands.....	25

In preparing this catalog it has been our aim to give something to the trade which is in keeping with the high standard of our merchandise. Our policy has always been to market a product that affords real service to the consumer, and contributes to the efficiency and successful operation of business institutions.

The service rendered by Sengbusch Products is responsible for our success—having given universal satisfaction during the past twenty-five years.

SENGBUSCH SELF-CLOSING INKSTAND CO.
MILWAUKEE, WISCONSIN, U. S. A.



With Genuine Bronze Ornaments

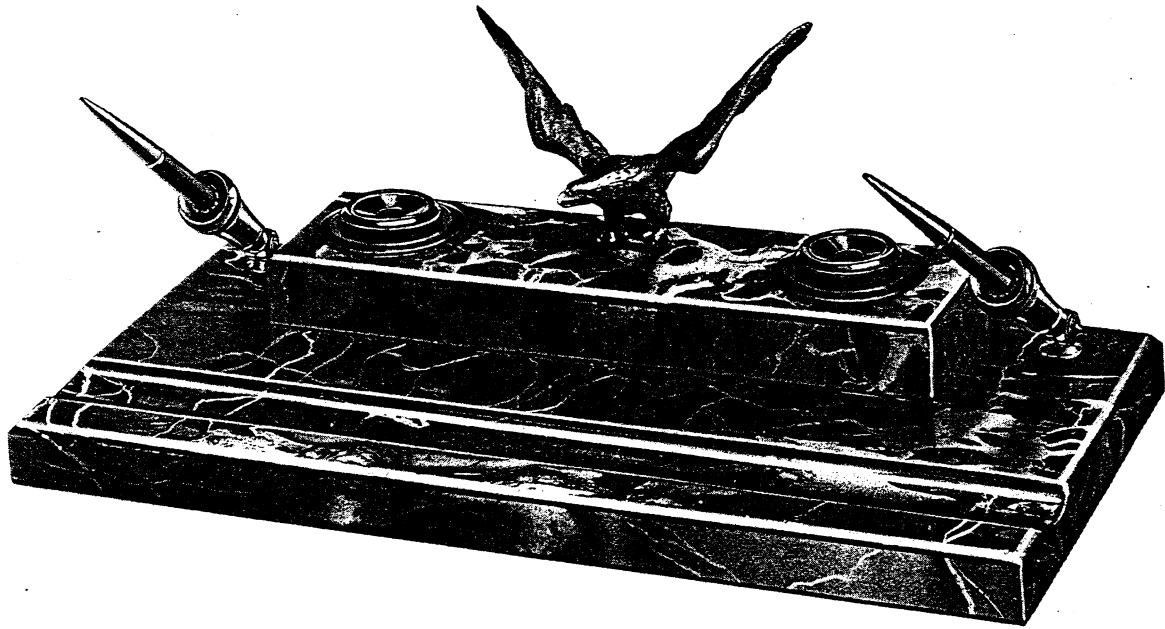

No. 2018—Portoro Marble

Price Complete with two No. 63 Pens.....\$86.00
 Without "Eagle" Ornament..... 71.00
 Size of Base 16x8 Inches

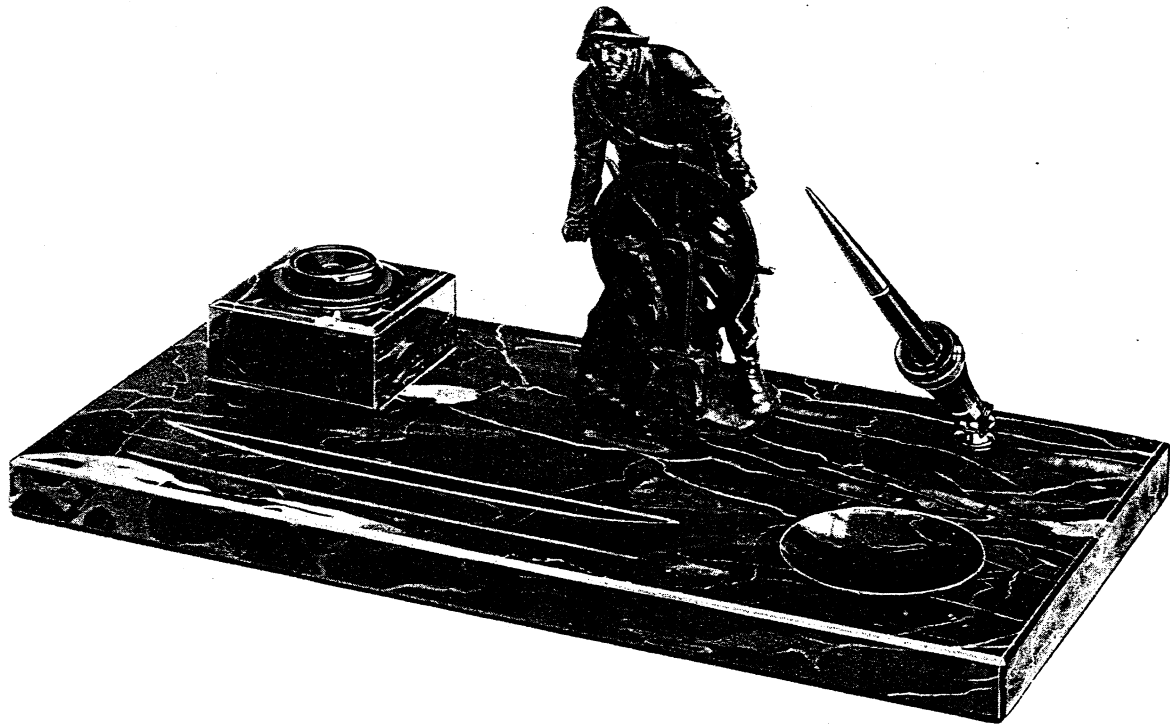

No. 2017—Portoro Marble

Price Complete with one No. 63 Pen.....\$100.00
 Without "Pilot" Ornament..... 55.00
 Size of Base 16x8 Inches



With Genuine Bronze Ornaments

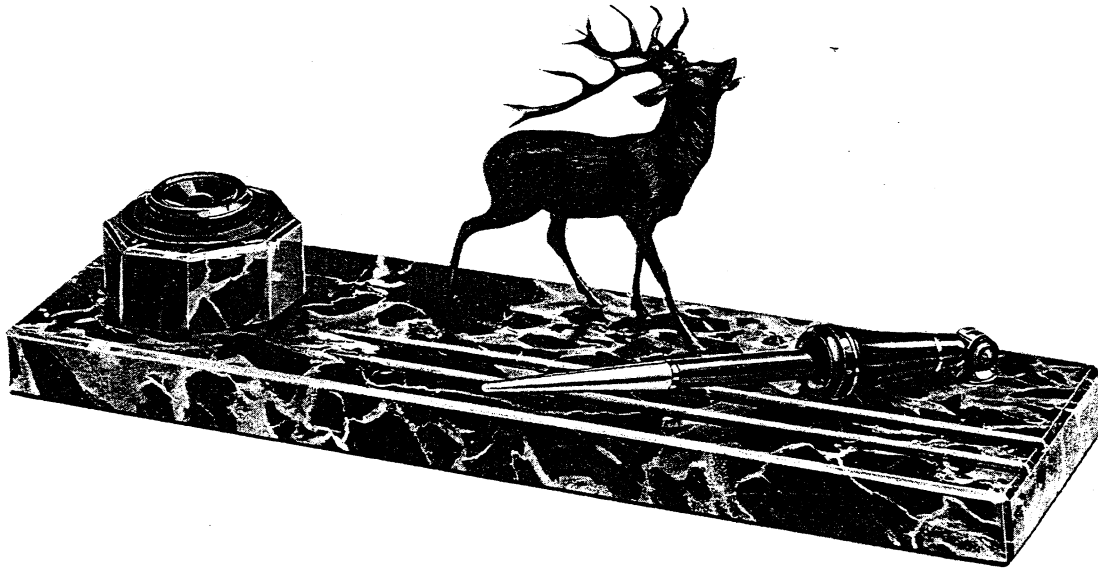

No. 2005—Portoro Marble

Price Complete with one No. 63 Pen.....\$58.00
 Without "Deer" Ornament..... 33.00

Size of Base 15x4½ Inches

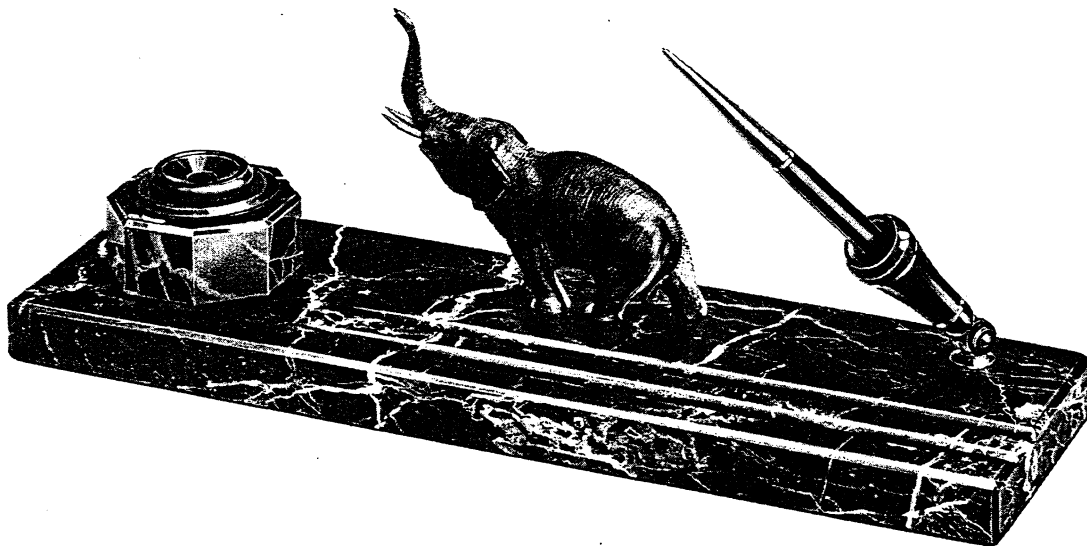

No. 2005—Portoro Marble

Price Complete with one No. 63 Pen.....\$65.50
 Without "Elephant" Ornament..... 33.00

Size of Base 15x4½ Inches



With Genuine Bronze Ornaments

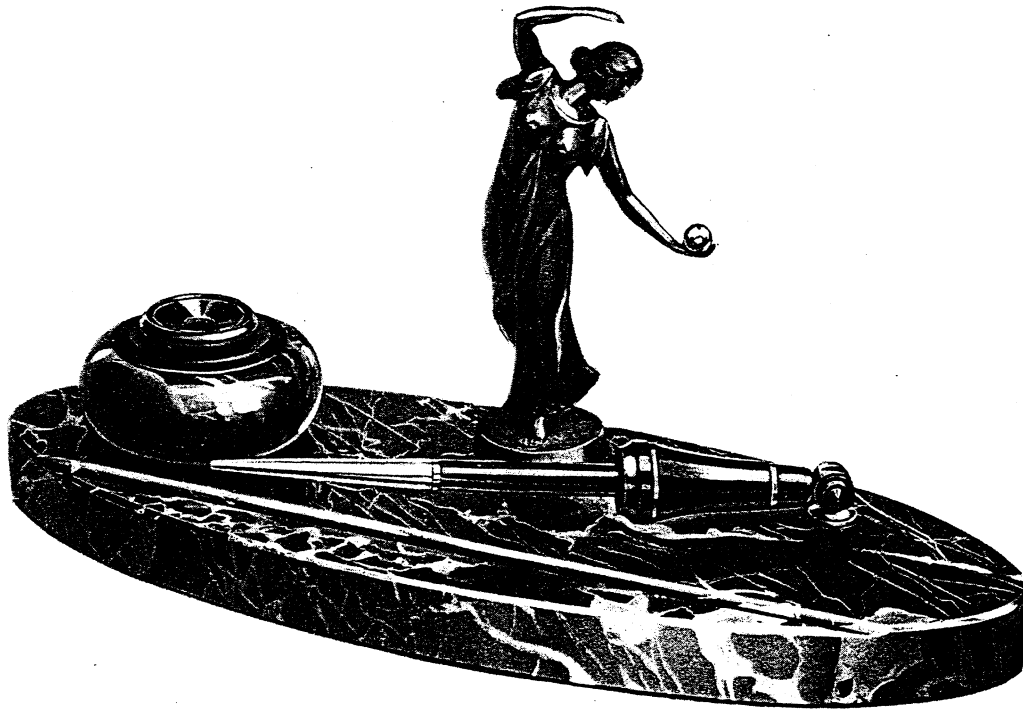

No. 2002—Portoro Marble

Price Complete with one No. 63 Pen.....\$60.50
 Without "Lady with Ball" Ornament..... 35.50
 Size of Base 14x5½ Inches

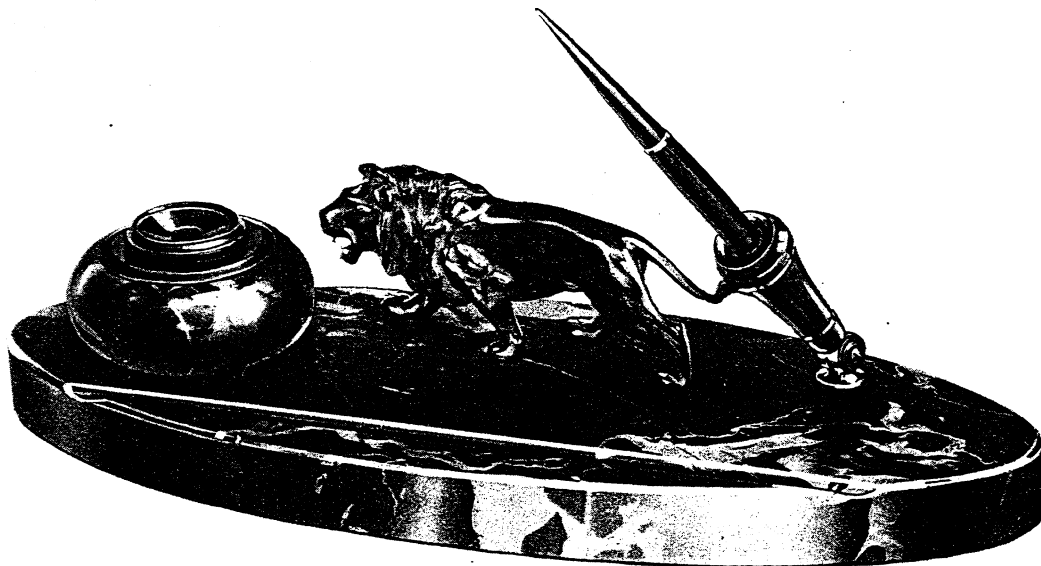

No. 2002—Portoro Marble

Price Complete with one No. 63 Pen.....\$60.50
 Without "Lion" Ornament..... 35.50
 Size of Base 14x5½ Inches



With Genuine Bronze Ornaments

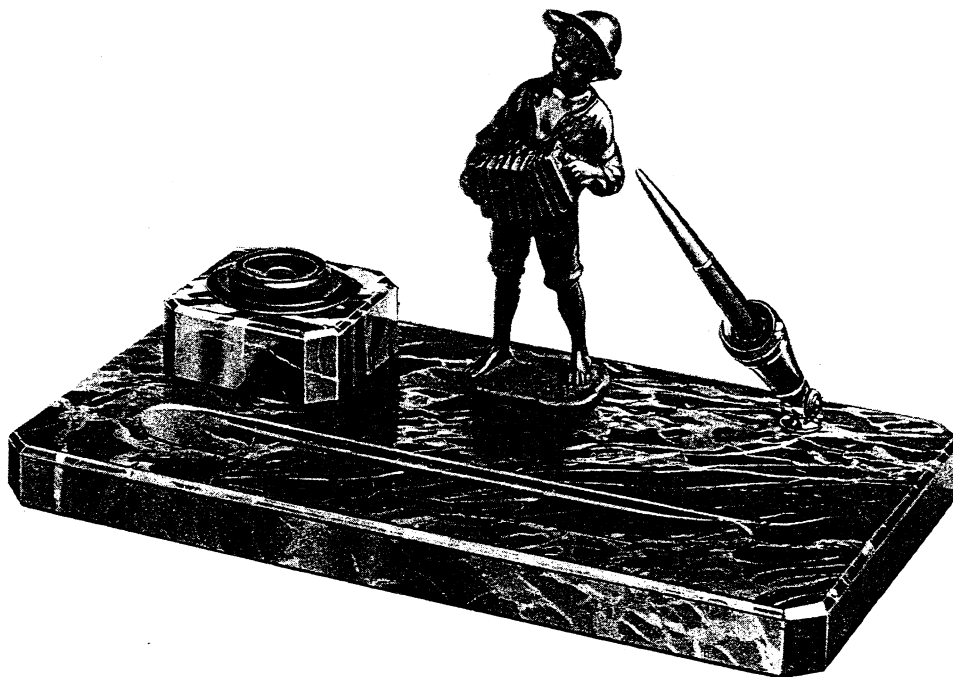

No. 2006—Portoro Marble

Price Complete with one No. 63 Pen.....\$65.50
 Without "Accordion Player" Ornament..... 50.50

Size of Base 13x7½ Inches

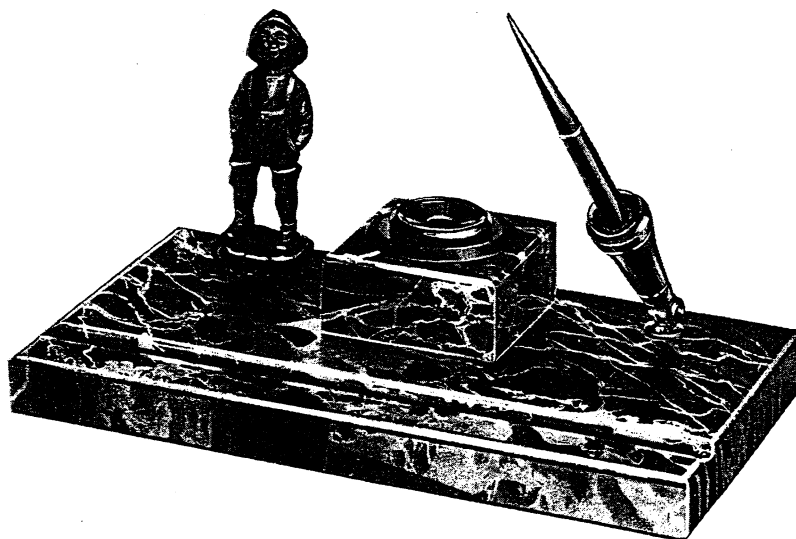

No. 2007—Portoro Marble

Price Complete with one No. 43 Pen.....\$41.00
 Without "Boy Smoker" Ornament..... 31.00

Size of Base 11x6 Inches



With Genuine Bronze Ornaments

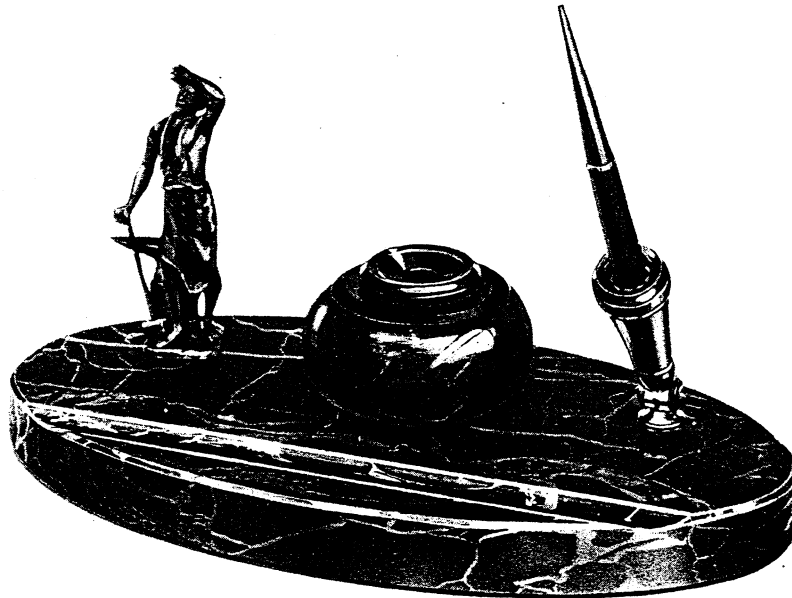

No. 2003—Portoro Marble
 Price Complete with one No. 43 Pen..... \$42.00
 Without "Blacksmith" Ornament..... 32.00
 Size of Base 11x5½ Inches

Marble and Onyx Desk Accessories

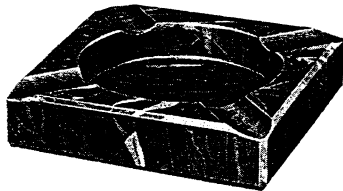

Price, \$7.50 Each

- No. 582—Portoro Marble Ash Tray
 - No. 583—Genuine Onyx Ash Tray
 - No. 584—Benou Jaune Marble Ash Tray
 - No. 585—Bois Jourdan Marble Ash Tray
- Size 4½-Inch Square

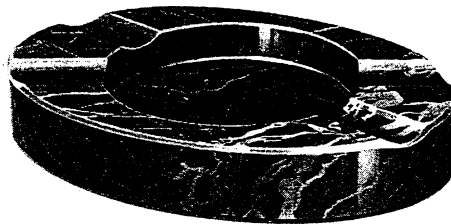

Price, \$8.50 Each

- No. 592—Portoro Marble Ash Tray
 - No. 593—Genuine Onyx Ash Tray
 - No. 594—Benou Jaune Marble Ash Tray
 - No. 595—Bois Jourdan Marble Ash Tray
- Size 6x4½-Inch Oval

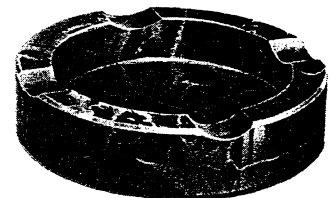

Price, \$7.50 Each

- No. 572—Portoro Marble Ash Tray
 - No. 573—Genuine Onyx Ash Tray
 - No. 574—Benou Jaune Marble Ash Tray
 - No. 575—Bois Jourdan Marble Ash Tray
- Size 4½-Inch Round



Price Complete \$7.00

- No. 504—Emeraline Glass Paper Weight
 - No. 505—Black Glass Paper Weight
 - No. 506—Portoro Marble Paper Weight
 - No. 507—Genuine Onyx Paper Weight
 - No. 508—Benou Jaune Marble Paper Weight
 - No. 509—Bois Jourdan Marble Paper Weight
- Size 4½x2½ Inches

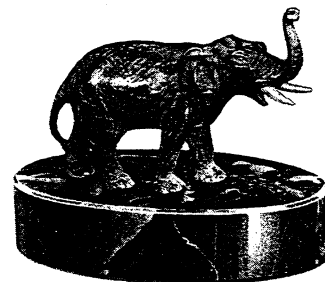

Price Complete \$8.00

- No. 514—Emeraline Glass Paper Weight
 - No. 515—Black Glass Paper Weight
 - No. 516—Portoro Marble Paper Weight
 - No. 517—Genuine Onyx Paper Weight
 - No. 518—Benou Jaune Marble Paper Weight
 - No. 519—Bois Jourdan Marble Paper Weight
- Size 4½x2¼-Inch Oval

Choice of Lion, Police Dog or Elephant Ornament.



A Suggestion to Increase Your Sales

Additional sales may easily be obtained if salesmen suggest buying complete combination desk sets similar to the one illustrated below.

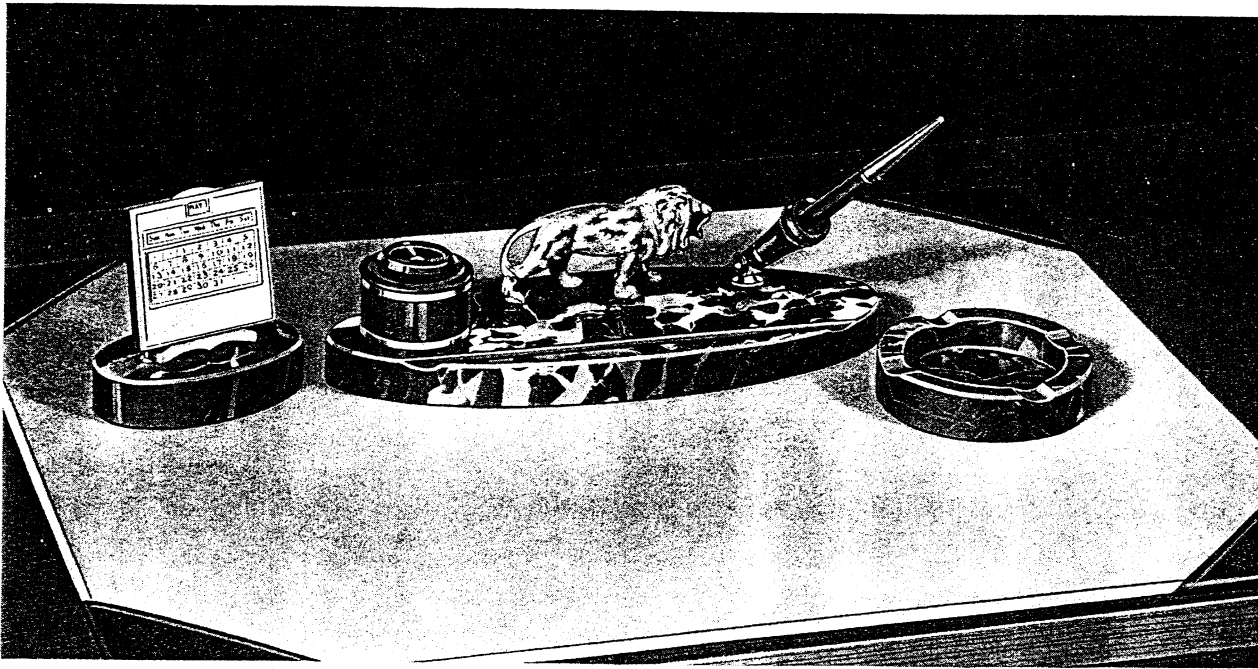

Price Complete \$44.00

Consisting of

No. 1882—Portoro Marble Dipaday Desk Set.....	\$29.50
No. 832—Portoro Marble Perpetual Calendar.....	7.00
No. 572—Portoro Marble Ash Tray.....	7.50
	<hr/>
	\$44.00

Dipaday desk sets and accessories offer a wide selection of bases, styles and colors—many other attractive combinations are possible.